

1.92–2.17 GHz WCDMA Ceramic Antenna

Ground cleared under antenna, clearance area 10.60 x 8.25 mm

Pulse Part Number: W3040



Features

- Low profile
- Compact size W x L x H (10 x 3.2 x 2 mm)
- Low weight (310 mg)
- Lead free materials
- Fully SMD compatible
- Lead free soldering compatible
- Tape and reel packing
- RoHS Compliant Product

Applications

- W-CDMA
- 1.92–2.17 GHz

Electrical specifications @ +25 °C

Note: Electrical characteristics depend on test board (GP) size and antenna positioning on GP and Ground Clearance area size.

WCDMA 1.92–2.17 GHz W3040

Typical performance

(test board size 80 x 37 mm, antenna position side center, PWB ground clearance area 10.60 x 8.25 mm)

Frequency Range [MHz]	Linear Max Gain [dBic]	Efficiency [%] / [dB]	Return loss min. [dB]	Impedance [Ω]	Operating Temperature [°C]
1920–2170	2.3 (Peak) 1.5 (Band edges)	80 / -1 (Peak) 70 / -1.55 (Band edges)	-10	50	-40 to +85

Pulse Finland Oy

Takatie 6
90440 Kempele, Finland
Tel: +358 207 935 500
Fax: +358 207 935 501

www.pulseeng.com/antennas



1.92–2.17 GHz WCDMA Ceramic Antenna

Ground cleared under antenna, clearance area 10.60 mm x 8.25 mm

Pulse Part Number: W3040

Terminal Configuration

Layout

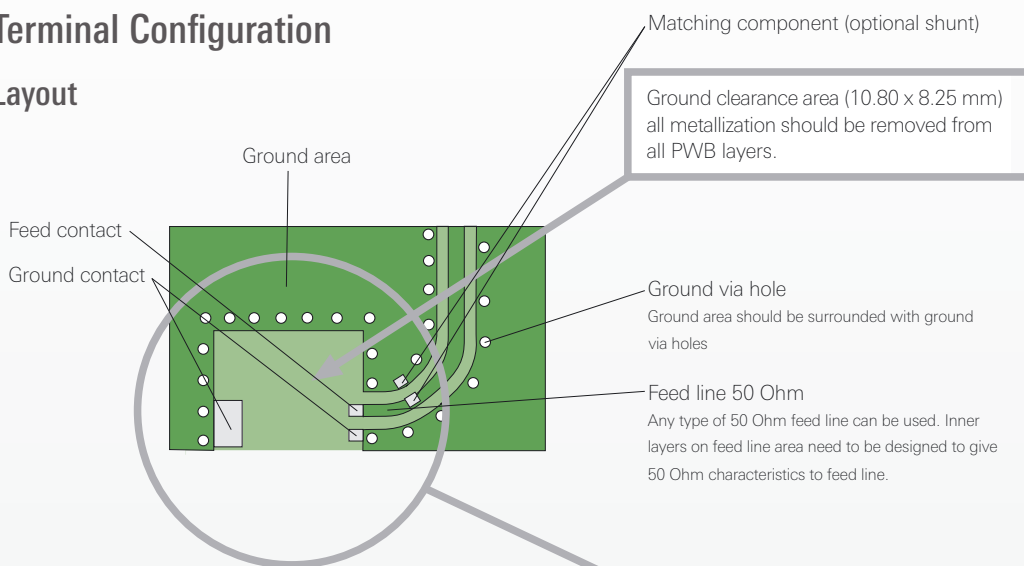

Antenna

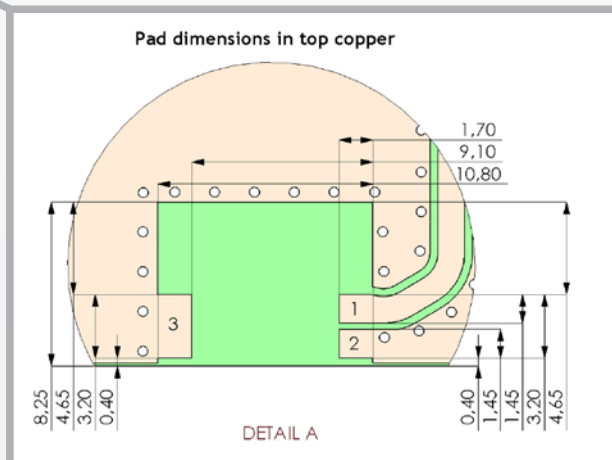
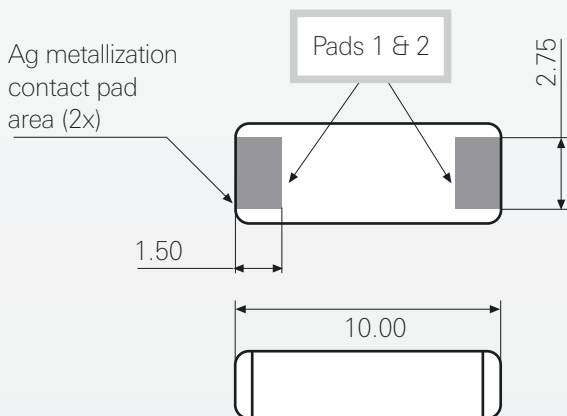

Antenna features

No.	Terminal Name	Terminal Dimensions
1	Feed / GND	1.50 x 2.75 mm
2	Feed / GND	1.50 x 2.75 mm

Antenna is symmetrical.
Either of terminals 1 or 2 can be Feed / GND

PWB features

No.	Terminal Name	Terminal Dimensions
1	Feed	1.70 x 1.45 mm
2	GND	1.70 x 1.45 mm
3	GND	1.70 x 3.20 mm

Pulse Finland Oy

Takatie 6
90440 Kempele, Finland
Tel: +358 207 935 500
Fax: +358 207 935 501
www.pulseeng.com/antennas



1.92–2.17 GHz WCDMA Ceramic Antenna

Ground cleared under antenna, clearance area 10.60 x 8.25 mm

Pulse Part Number: W3040

W3040 Typical Electrical Characteristics (T=25 °C)

Measured on the 80 x 37 mm test board. Antenna location side center. 2.7pF shunt matching capacitor used.

Typical Return Loss S11/ impedance.

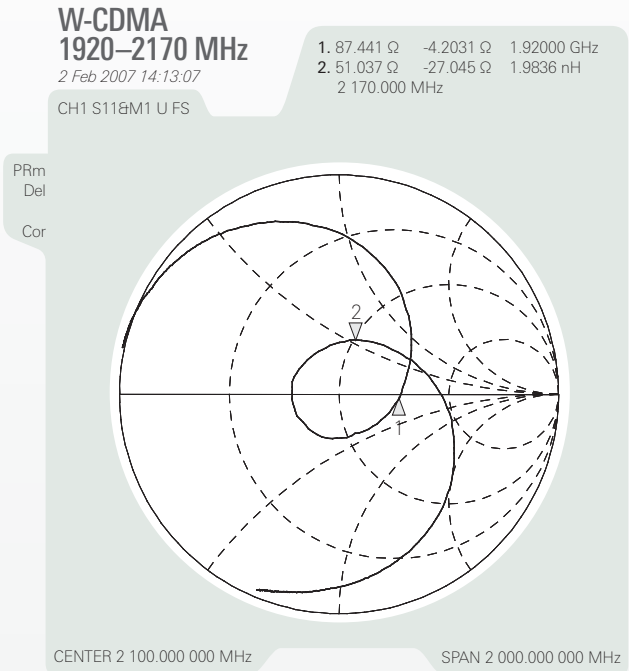
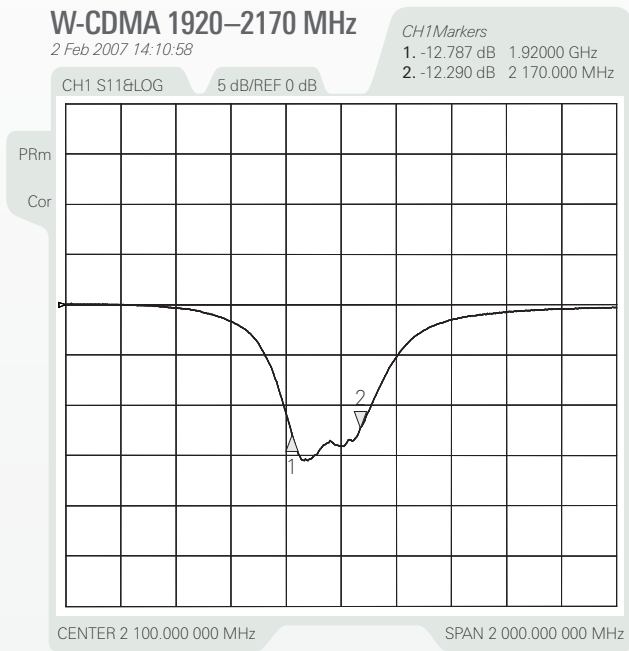

Free space efficiency and maximum gain

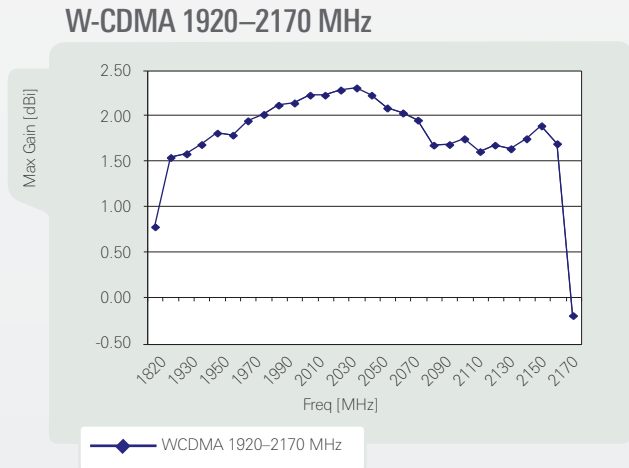
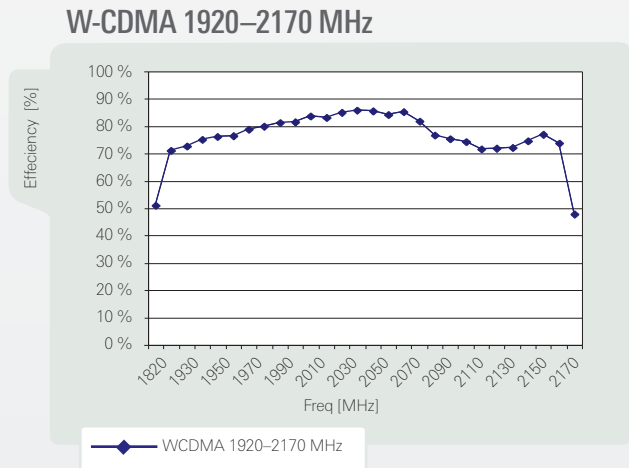

Pulse Finland Oy

Takatie 6
90440 Kempele, Finland
Tel: +358 207 935 500
Fax: +358 207 935 501
www.pulseeng.com/antennas



1.92–2.17 GHz WCDMA Ceramic Antenna

Ground cleared under antenna, clearance area 10.60 x 8.25 mm

Pulse Part Number: W3040

W3040 Typical Free Space Radiation Patterns

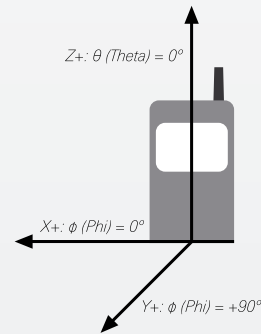
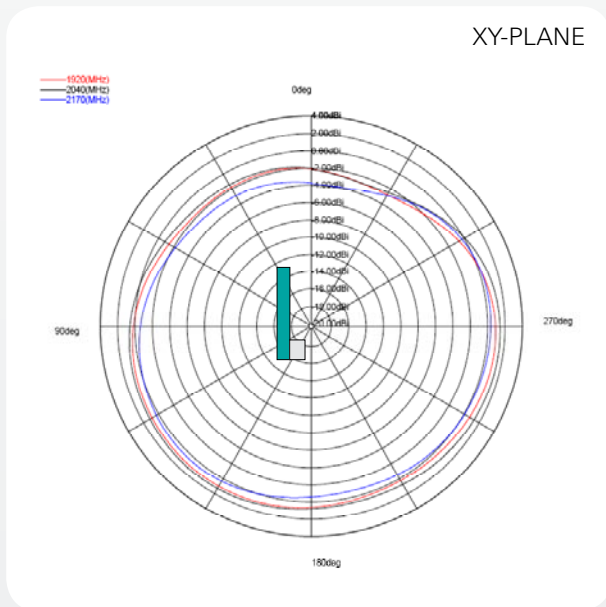
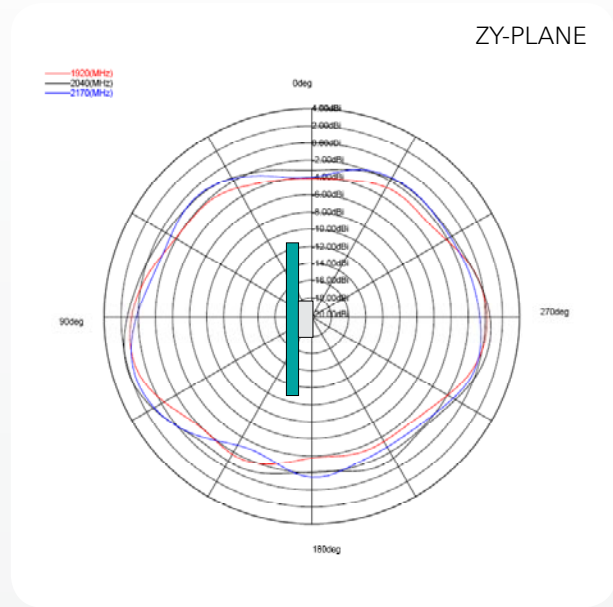
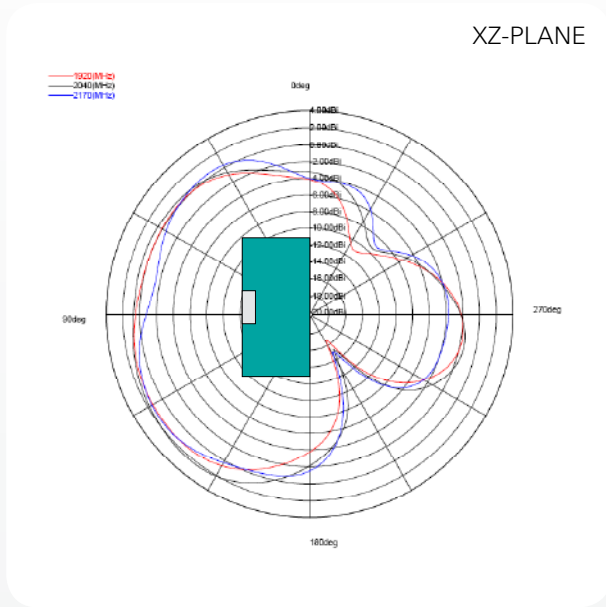

Pulse Finland Oy

Takatie 6
 90440 Kempele, Finland
 Tel: +358 207 935 500
 Fax: +358 207 935 501

www.pulseeng.com/antennas



1.92–2.17 GHz WCDMA Ceramic Antenna

Ground cleared under antenna, clearance area 10.60 x 8.25 mm

Pulse Part Number: W3040

Packing Form

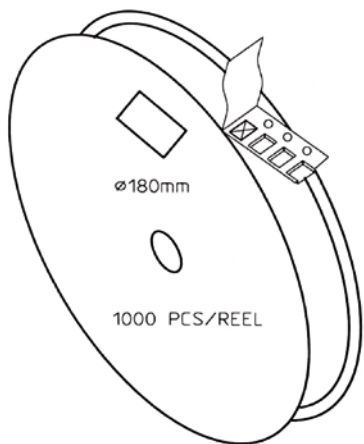

CARRIER TAPE H85-00188
width=24,00 depth=2.20
COVER TAPE H85-00159
width=21.20

LENGTH OF TAPE:

- Leader section: min 350 mm before component section
- Trailer section: min 40 mm after component section.

Empty part cavities at leader and trailer section of the tape must be sealed with top cover tape.

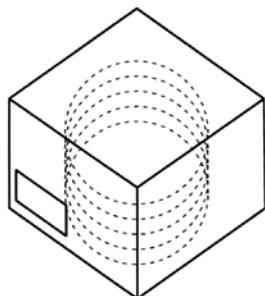

BOX H85-00128 1 pcs
(182x182x125)
- LABEL 1 pcs/BOX

REEL H85-00160 4 pcs
(D180, W28)
- REEL LABEL 1 pcs/REEL

MATERIAL

HANDLINGS

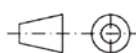
		RATIO	DRWN	160107 PeHa	H
			DGNER		G
			CHKD		F
			APPRD		E
PRODUCT	H90-OY113-F01P01	APPRD BY			D
DENOMINATION	PACKING FORM				C
					B
					A
		VERSION			MOD/DATE/NAME

Pulse Finland Oy

Takatie 6
90440 Kempele, Finland
Tel: +358 207 935 500
Fax: +358 207 935 501
www.pulseeng.com/antennas

