

CoolMOS™ 1) Power MOSFET

ISOPLUS™ - electrically isolated surface to heatsink

Surface Mount Power Device

$$V_{DSS} = 600 \text{ V}$$

$$I_{D25} = 50 \text{ A}$$

$$R_{DS(on) \text{ max}} = 45 \text{ m}\Omega$$

Preliminary data

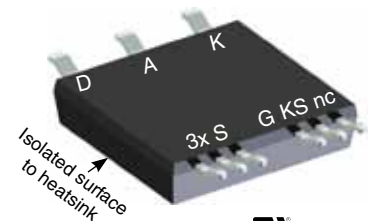
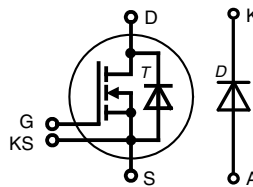

E72873

MOSFET T		Maximum Ratings	
Symbol	Conditions		
V_{DSS}	$T_{VJ} = 25^\circ\text{C to } 150^\circ\text{C}$	600	V
V_{GS}		± 20	V
I_{D25}	$T_C = 25^\circ\text{C}$	50	A
I_{D80}	$T_C = 80^\circ\text{C}$	38	A
E_{AS} E_{AR}	single pulse repetitive } $I_D = 11 \text{ A}; T_C = 25^\circ\text{C}$	1950 3	mJ mJ
dV/dt	MOSFET dV/dt ruggedness $V_{DS} = 0 \dots 480 \text{ V}$	50	V/ns

Symbol	Conditions	Characteristic Values				
		min.	typ.	max.		
($T_{VJ} = 25^\circ\text{C}$, unless otherwise specified)						
$R_{DS(on)}$	$I_D = 44 \text{ A}; V_{GS} = 10 \text{ V}$		40	45	m Ω	
$V_{GS(th)}$	$I_D = 3 \text{ mA}; V_{DS} = V_{GS}$	2.5	3	3.5	V	
I_{DSS}	$V_{DS} = V_{DSS}; V_{GS} = 0 \text{ V}; T_{VJ} = 25^\circ\text{C}$ $T_{VJ} = 125^\circ\text{C}$		50	10	μA μA	
I_{GSS}	$V_{DS} = 0 \text{ V}; V_{GS} = \pm 20 \text{ V}$			100	nA	
$t_{d(on)}$ t_r $t_{d(off)}$ t_f	Inductive switching boost mode with diode D $V_{DS} = 380 \text{ V}; I_D = 30 \text{ A}$ $V_{GS} = 10 \text{ V}; R_G = 33 \Omega$		80		ns	
E_{on}			40		ns	
E_{off}			750		ns	
E_{rec}			40		ns	
C_{iss} C_{oss}	$V_{GS} = 0 \text{ V}; V_{DS} = 100 \text{ V}; f = 1 \text{ MHz}$		6800		pF	
				320		pF
Q_g Q_{gs} Q_{gd}	$V_{DS} = 400 \text{ V}; I_D = 44 \text{ A}$ $V_{GS} = 10 \text{ V}; R_G = 3.3 \Omega$		150	190	nC	
				35		nC
				50		nC
R_{thJC} R_{thJH}	with heatsink compound (IXYS test setup)		0.4		K/W	
			tbd	tbd		K/W

Features

- **Fast CoolMOS™ 1)** power MOSFET 4th generation
 - high blocking capability
 - lowest resistance
 - avalanche rated for unclamped inductive switching (UIS)
 - low thermal resistance due to reduced chip thickness
- **Package**
 - isolated surface to heatsink
 - low coupling capacity between pins and heatsink
 - PCB space saving
 - enlarged creepage towards heatsink
 - application friendly pinout
 - low inductive current path
 - high reliability

Applications

- Buck / boost chopper
- Optimized for boost configuration
- PFC stage

¹⁾ CoolMOS™ is a trademark of Infineon Technologies AG.

Source-Drain Diode of MOSFET T					
Symbol	Conditions	Maximum Ratings			
I_{S25}	$T_C = 25^\circ\text{C}$	50	A		
I_{S80}	$T_C = 80^\circ\text{C}$	38	A		
Symbol	Conditions	Characteristic Values			
($T_{VJ} = 25^\circ\text{C}$, unless otherwise specified)					
V_{SD}	$I_F = 44\text{ A}; V_{GS} = 0\text{ V}$		0.9	1.0	V
t_{rr}	$I_F = 44\text{ A}; -di_F/dt = 100\text{ A}/\mu\text{s}; V_R = 400\text{ V}$		600		ns
Q_{RM}			17		μC
I_{RM}			60		A

Diode D					
Symbol	Conditions	Maximum Ratings			
I_{F25}	$T_C = 25^\circ\text{C}; \text{DC}$	96	A		
I_{F80}	$T_C = 80^\circ\text{C}; \text{DC}$	61	A		
Symbol	Conditions	Characteristic Values			
($T_{VJ} = 25^\circ\text{C}$, unless otherwise specified)					
V_{RRM}		$T_{VJ} = 25^\circ\text{C}$		600	V
V_F	$I_F = 25\text{ A}$	$T_{VJ} = 25^\circ\text{C}$	1.2	1.4	V
		$T_{VJ} = 125^\circ\text{C}$	1.3		
I_R	$V_R = V_{RRM}$	$T_{VJ} = 25^\circ\text{C}$		150	μA
		$T_{VJ} = 125^\circ\text{C}$	tbd		mA
I_{RM}	$I_F = 30\text{ A}; V_R = 350\text{ V}$ $-di/dt = 240\text{ A}/\mu\text{s}$	$T_{VJ} = 100^\circ\text{C}$	10		A
t_{rr}	$I_F = 1\text{ A}; V_R = 30\text{ V}$ $-di/dt = 100\text{ A}/\mu\text{s}$	$T_{VJ} = 100^\circ\text{C}$	35	50	ns
R_{thJC}	per diode			0.7	K/W
R_{thJH}	with heatsink compound (IXYS test setup)		tbd		k/W

Component					
Symbol	Conditions	Maximum Ratings			
T_{VJ}		-55...+150 °C			
T_{stg}		-55...+125 °C			
V_{ISOL}	$I_{ISOL} \leq 1\text{ mA}; 50/60\text{ Hz}$	2500	V~		
F_C	mounting force	40 ... 130	N		
Symbol	Conditions	Characteristic Values			
C_p	coupling capacity between shorted pins and backside metal		90		pF
d_s, d_A	pin - pin	1.65			mm
d_s, d_A	pin - backside metal	4			mm
CTI		400			
Weight			8		g

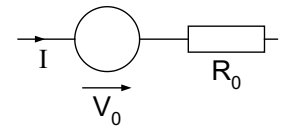
Equivalent Circuits for Simulation
Conduction

Boost Diode (typ. at $T_J = 125^\circ\text{C}$)
 $V_0 = \text{tbd V}; R_0 = \text{tbd m}\Omega$

Ordering	Part Number	Marking on Product	Delivering Mode	Base Qty	Ordering Code
Standard	MKE38RK600DFELB-TRR	MKE38RK600DFELB	Tape & Reel	200	510479
	MKE38RK600DFELB	MKE38RK600DFELB	Blister	45	510231

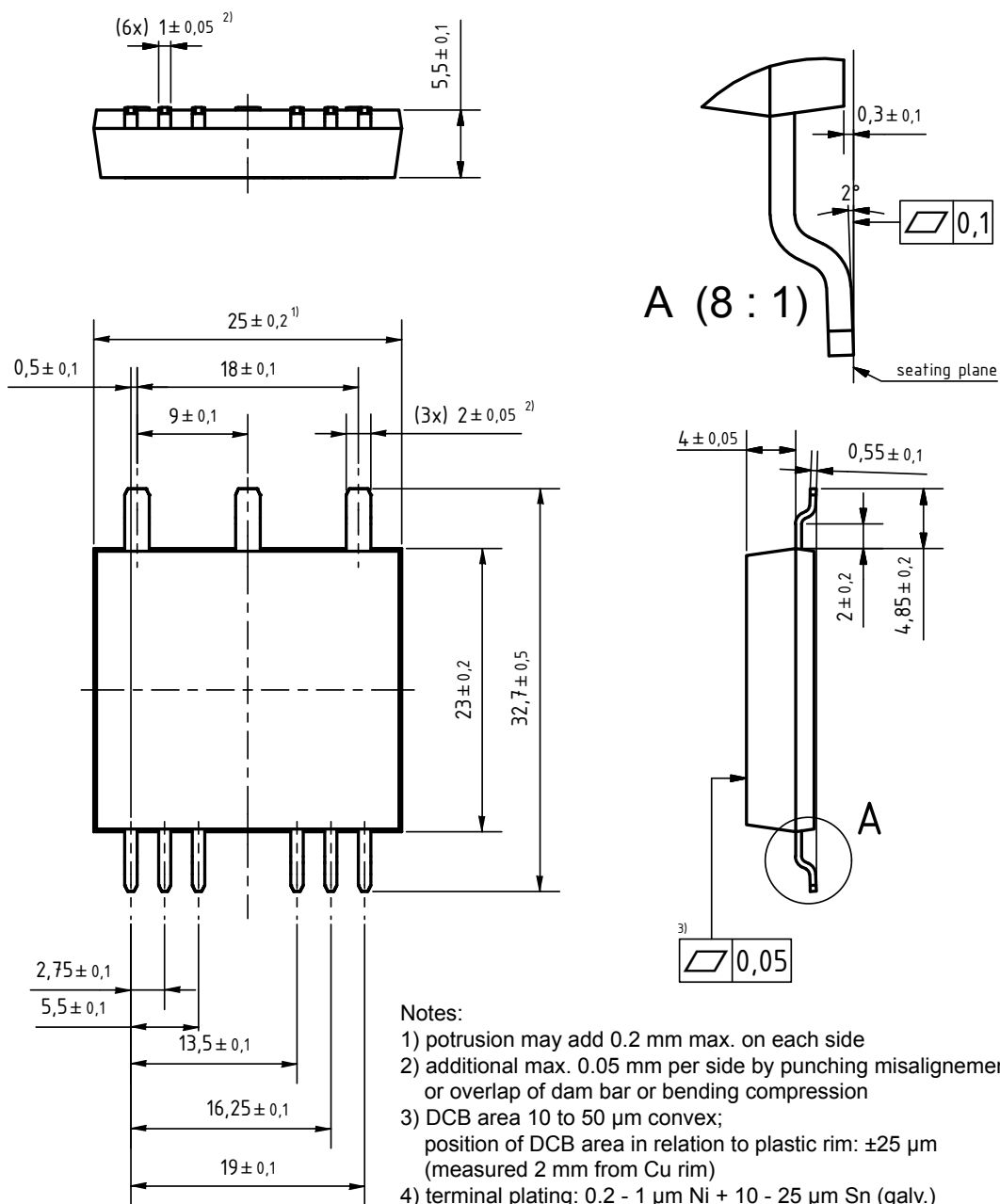
Notes:

- 1) protrusion may add 0.2 mm max. on each side
- 2) additional max. 0.05 mm per side by punching misalignment or overlap of dam bar or bending compression
- 3) DCB area 10 to 50 μ m convex; position of DCB area in relation to plastic rim: $\pm 25 \mu$ m (measured 2 mm from Cu rim)
- 4) terminal plating: 0.2 - 1 μ m Ni + 10 - 25 μ m Sn (galv.) cutting edges may be partially free of plating

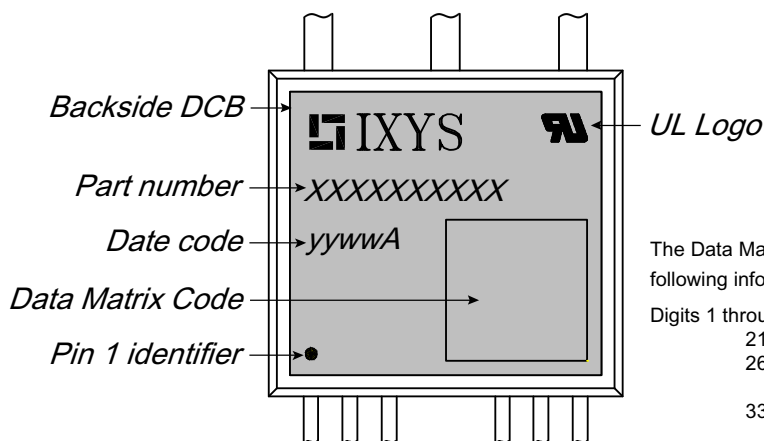

The Data Matrix Code contains the following information in 36 digits:

- Digits 1 through 20: part number
- 21 to 25: date code (YYWWA)
- 26 to 31: assembly lot code
- 32: reserved for special information
- 33 to 36: may be used for subsequent module numbering within the assembly lot

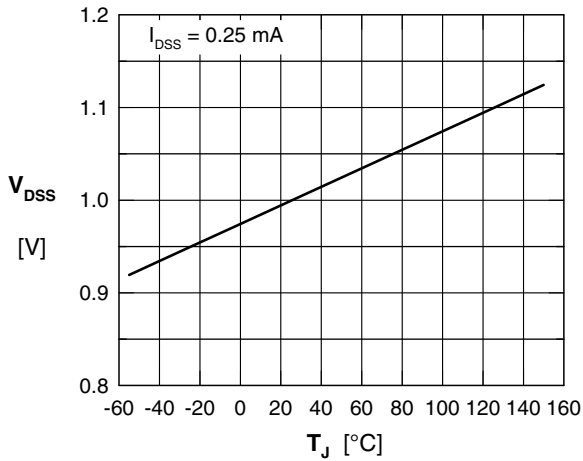

Fig. 1 Drain source breakdown voltage versus temperature T_{VJ}

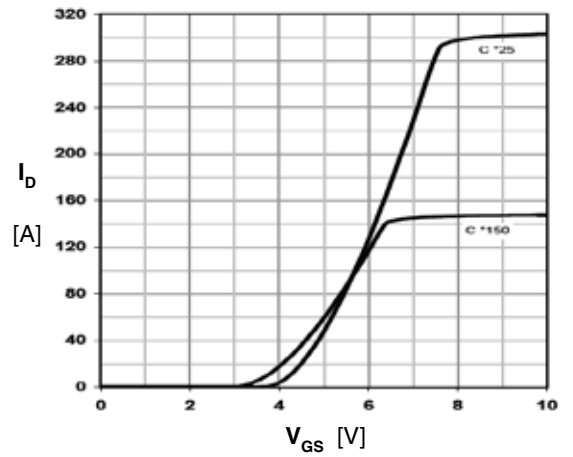

Fig. 2 Typ. transfer characteristics

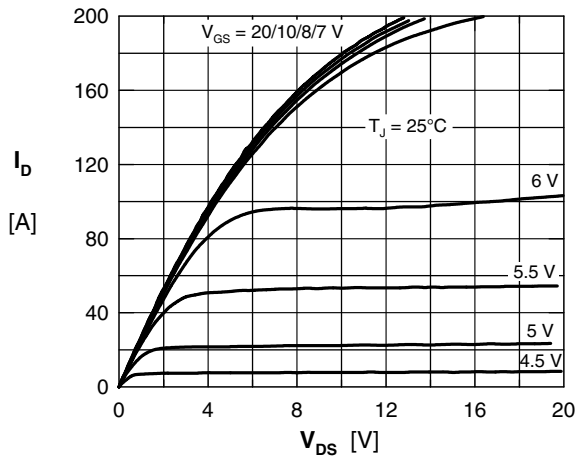

Fig. 3 Typical output characteristics

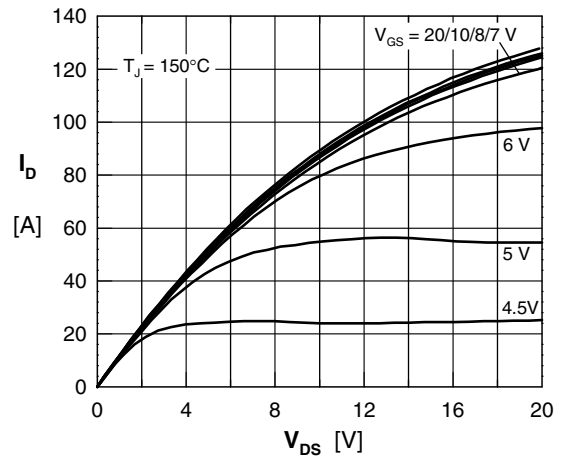

Fig. 4 Typical output characteristics

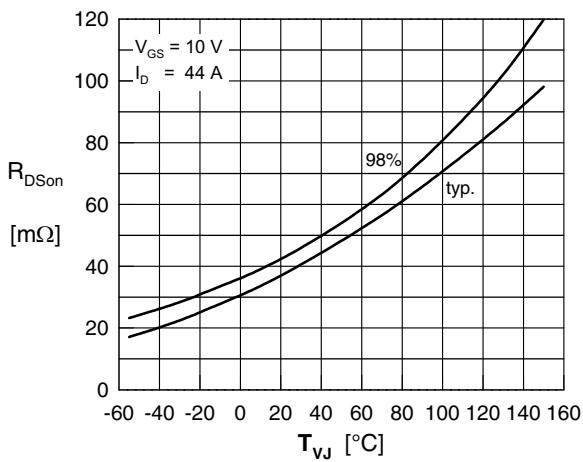

Fig. 5 Drain source on-state resistance $R_{DS(on)}$ vs. junction temperature T_{VJ}

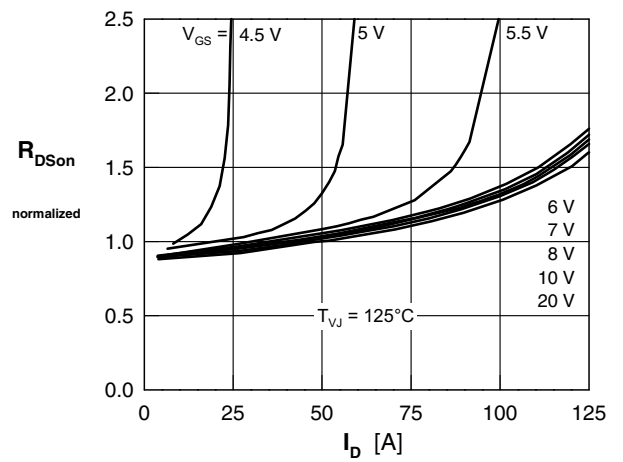

Fig. 6 Drain source on-state resistance, $R_{DS(on)}$ versus I_D

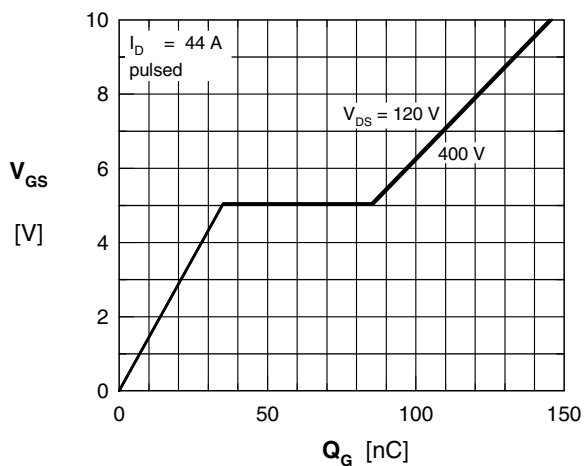

Fig. 7 Typ. turn-on gate charge

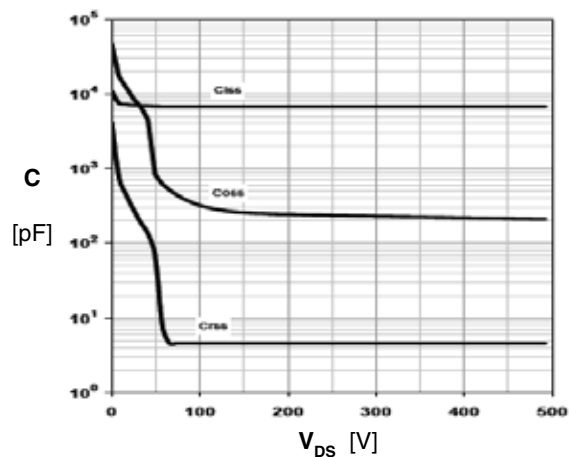

Fig. 8 Typ. capacities, MOSFET only

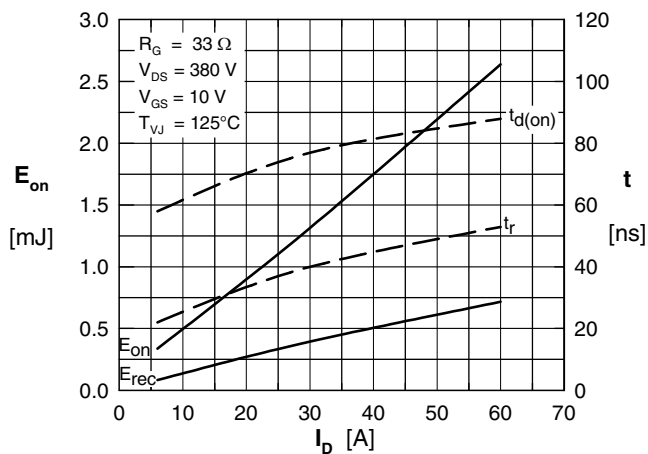

Fig. 9 Typ. turn-on energy and switching times vs. collector current, inductive switching

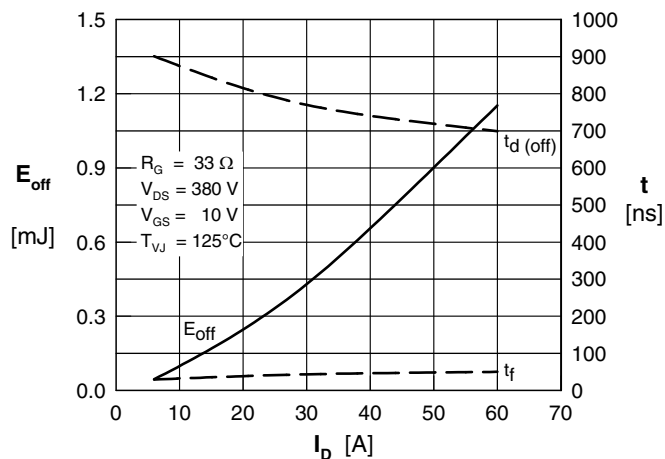

Fig. 10 Typ. turn-off energy and switching times vs. collector-current, inductive switching

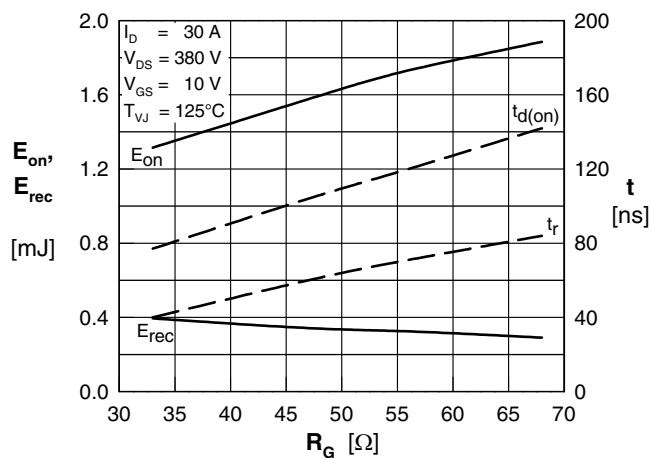

Fig. 11 Typ. turn-on energy and switching times vs. gate resistor, inductive switching

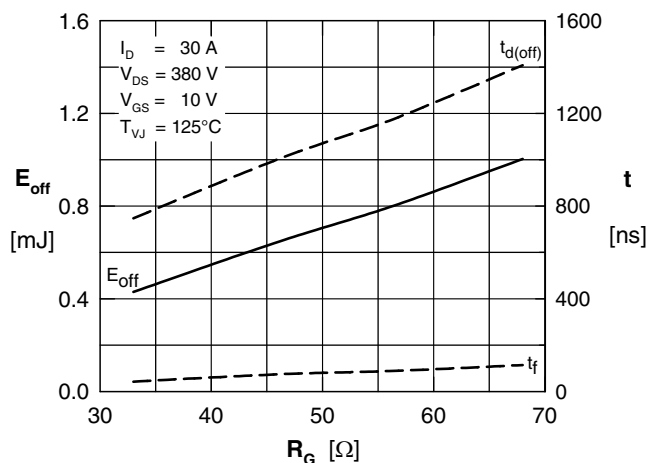

Fig. 12 Typ. turn-off energy and switching times vs. gate resistor, inductive switching

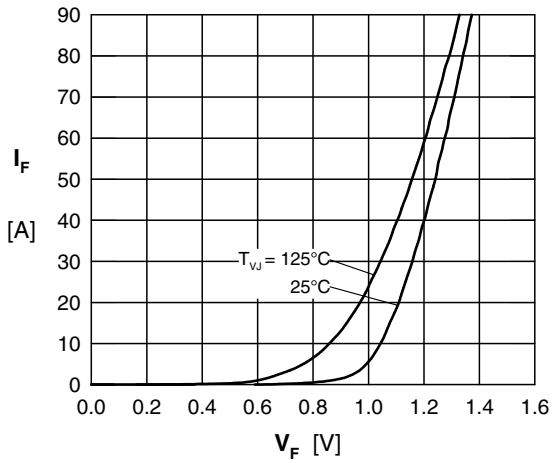

Fig. 13 Typ. forward characteristics of diode D

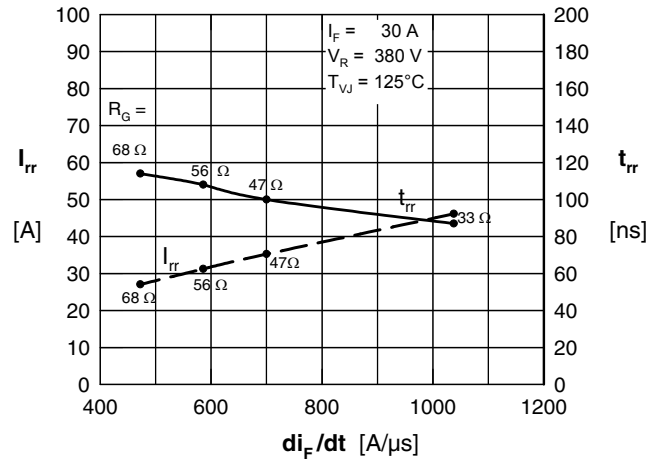

Fig. 14 Typ. reverse recovery characteristics of diode D

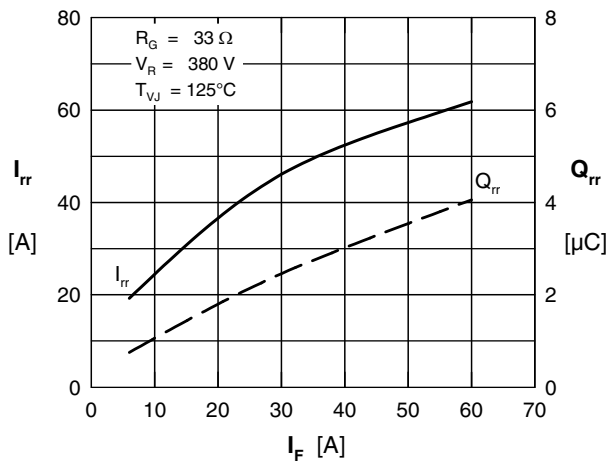

Fig. 15 Typ. reverse recovery characteristics of diode D