

Zero Height "Ultra-Mini" SiSonic™ Microphone Specification  
With MaxRF Protection and Extended Low Frequency  
Performance

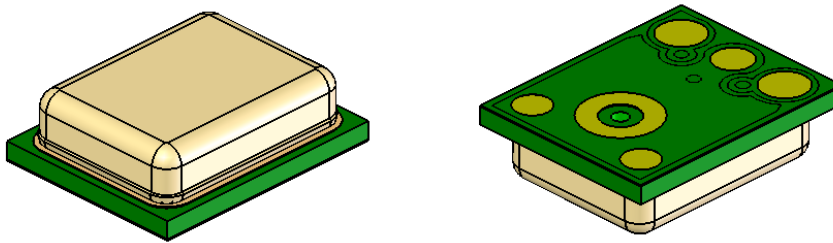

**Knowles Acoustics**  
1151 Maplewood Drive  
Itasca, IL 60143

## 1. DESCRIPTION AND APPLICATION

1.1 DESCRIPTION Zero Height "Ultra-mini" SiSonic Microphone with Maximum RF Protection and Extended Low Frequency Performance

1.2 APPLICATION Consumer electronics

## 2. PART MARKING

Identification Number Convention

S 1 2 3  
4 5 6 7

S: Identification Marking

"S" - Knowles SiSonic Production

"E" - Knowles Engineering Samples

Digits 1-7: Job Identification Number

## 3. MATERIALS STATEMENT

3.1 Meets the requirements of the European RoHS directive, 2002/95/EC as amended.

3.2 Meets the requirements of the industry-standard IEC 61249-2-21:2003 for halogenated substances and Knowles Green Materials Standards Policy section on Halogen-Free.

3.3 Ozone depleting substances are not used in the product or the processes used to make the product, including compounds listed in annex A, B, and C of the "Montreal Protocol on Substances that deplete the Ozone Layer."

## 4. TEMPERATURE RANGE

4.1 Operating Temperature Range: -40°C to +100°C

4.2 Storage Temperature Range: -40°C to +100°C

## 5. ABSOLUTE MAXIMUM RATINGS

Parameter	Absolute Maximum Rating	Unit
Supply Voltage, $V_{DD}$ to Ground	-0.5, +5.0	V
OUT to Ground	-0.3, $V_{DD}+0.3$	V
Input Current to Any Pin	$\pm 5$	mA

Stresses at these Absolute Maximum Ratings may cause permanent damage to the device. These are stress ratings only. The device may not function when operated at these or any other conditions beyond those indicated under "Acoustic & Electrical Specifications". Exposure beyond those indicated under "Acoustic & Electrical Specifications" for extended periods may affect device reliability.

## 6. ACOUSTIC & ELECTRICAL SPECIFICATIONS

TEST CONDITIONS: 23  $\pm$  2°C, 60-70% R.H.,  $V_{DD}(\min) \leq V_{DD} \leq V_{DD}(\max)$ , no load, unless otherwise specified

Parameter	Symbol	Condition	Limits			Unit
			Min.	Nom.	Max.	
Supply Voltage <sup>1</sup>	$V_{DD}$		1.5	---	3.6	V
Current Consumption <sup>1</sup>	$I_{DD}$		---	120	160	$\mu$ A
Directivity			Omni-directional			
Sensitivity <sup>1</sup>	S	94 dB SPL @ 1kHz	-41	-38	-35	dBV/Pa
Signal to Noise Ratio	SNR	94 dB SPL @ 1kHz, A-weighted	---	63	---	dB (A)
Output Impedance	$Z_{OUT}$	@ 1kHz	---	---	400	$\Omega$
Total Harmonic Distortion	THD	100 dB SPL @ 1kHz, $R_{load} > 3k\Omega$	---	---	1	%
		115 dB SPL @ 1kHz, $R_{load} > 3k\Omega$	---	---	10	%
Polarity		Increasing sound pressure	Increasing output voltage			

<sup>1</sup> 100% tested

## 7. FREQUENCY RESPONSE CURVE

TYPICAL FREE FIELD RESPONSE  
NORMALIZED TO 1kHz

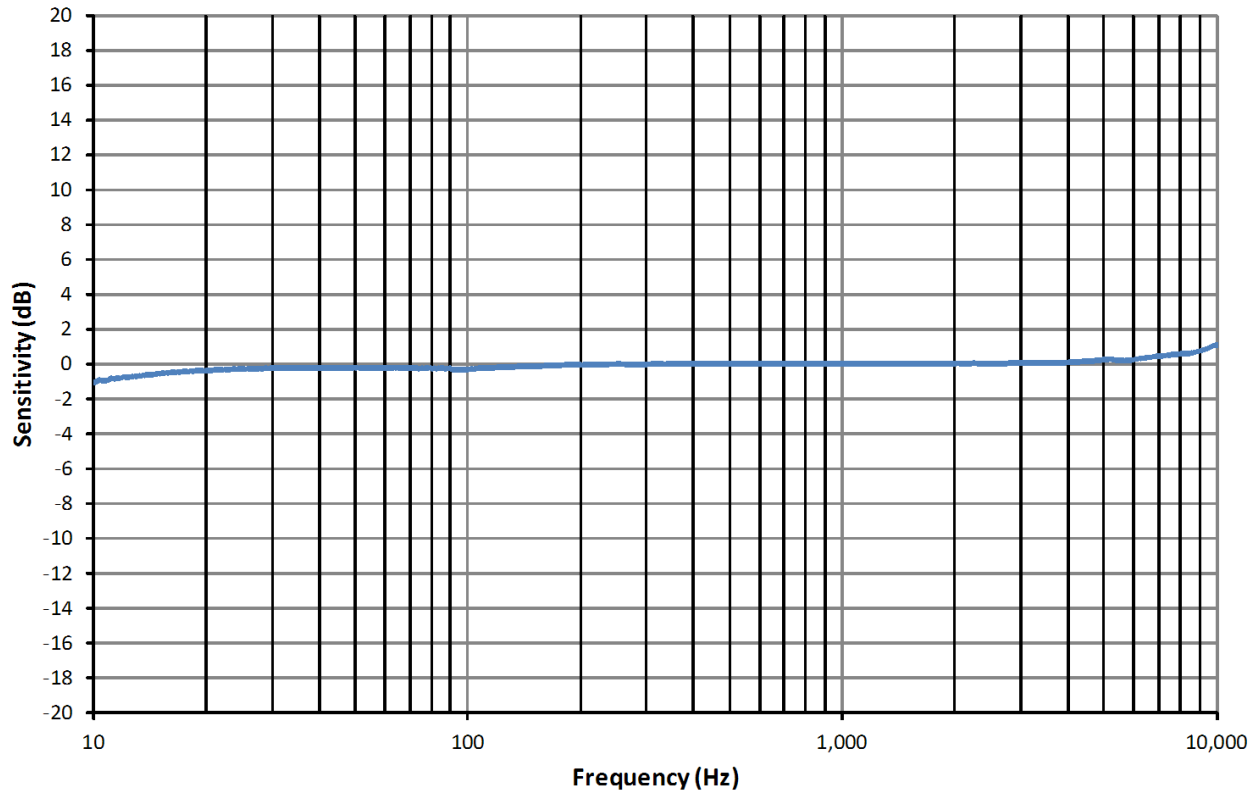

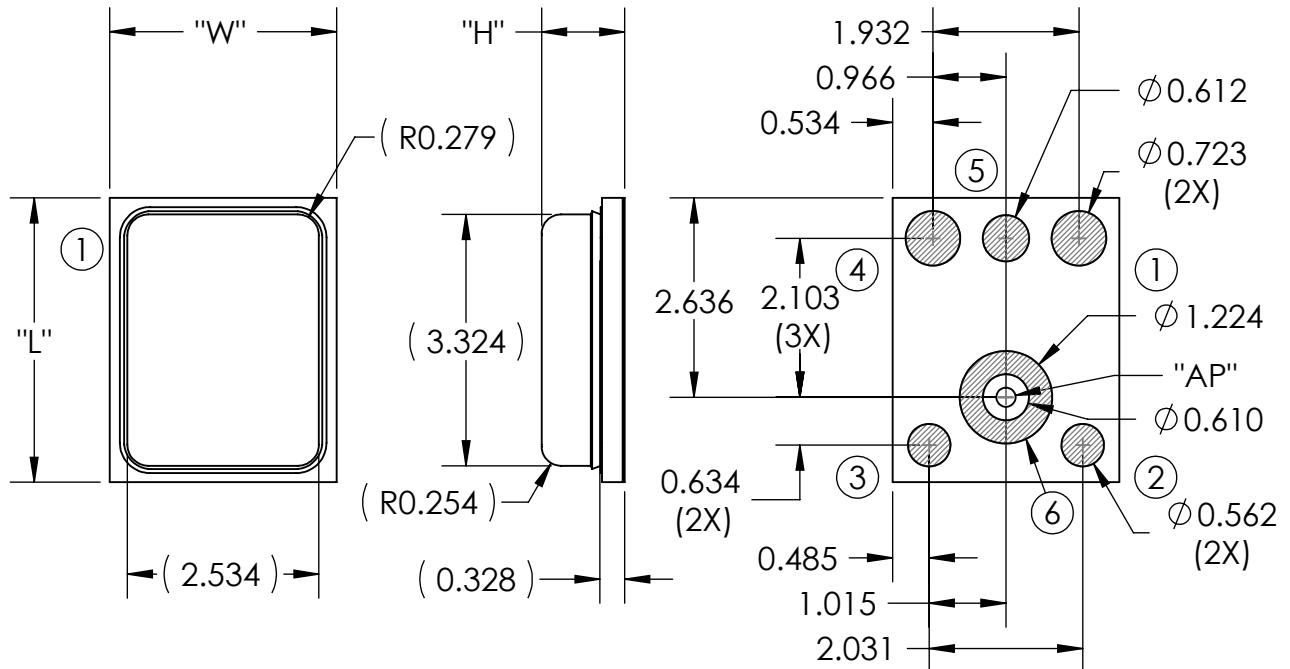
**8. MECHANICAL SPECIFICATIONS**

ITEM	DIMENSION	TOLERANCE	UNITS
LENGTH (L)	3.760	±0.100	mm
WIDTH (W)	3.000	±0.100	mm
HEIGHT (H)	1.100	±0.100	mm
ACOUSTIC PORT (AP)	Ø0.25	±0.08	mm

PIN OUTPUT	
PIN #	FUNCTION
1	OUTPUT
2	GROUND
3	GROUND
4	POWER (V <sub>DD</sub> )
5	GROUND
6	GROUND

**Note:**

Dimensions are in millimeters unless otherwise specified.

Tolerance ±0.15mm unless otherwise specified.

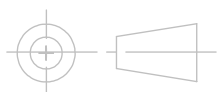

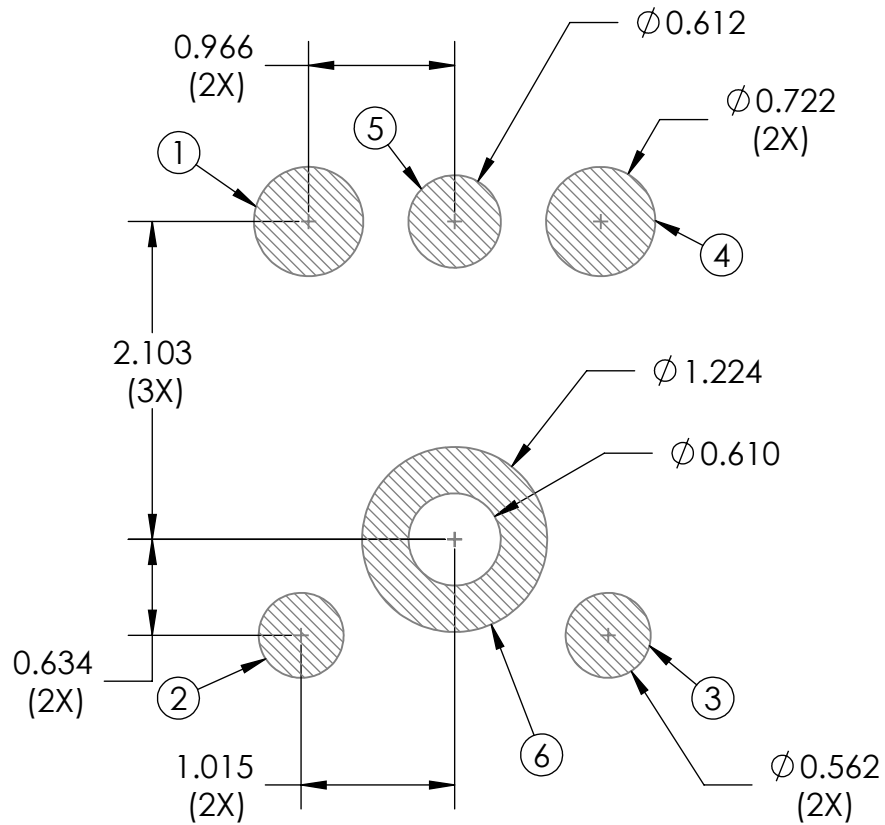
**9. RECOMMENDED CUSTOMER LAND PATTERN**

Note: For solder stencil information please contact Knowles.

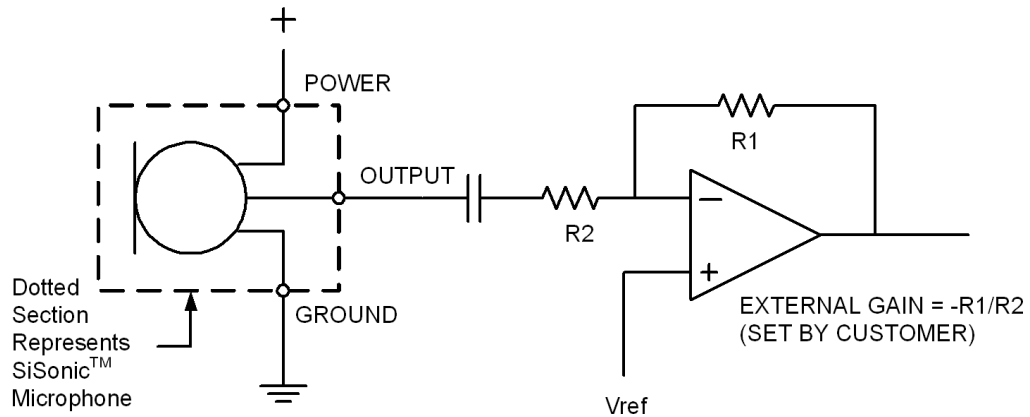
**10. RECOMMENDED INTERFACE CIRCUIT**

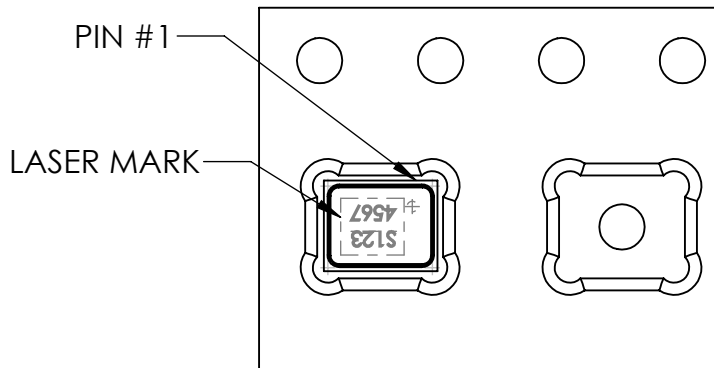
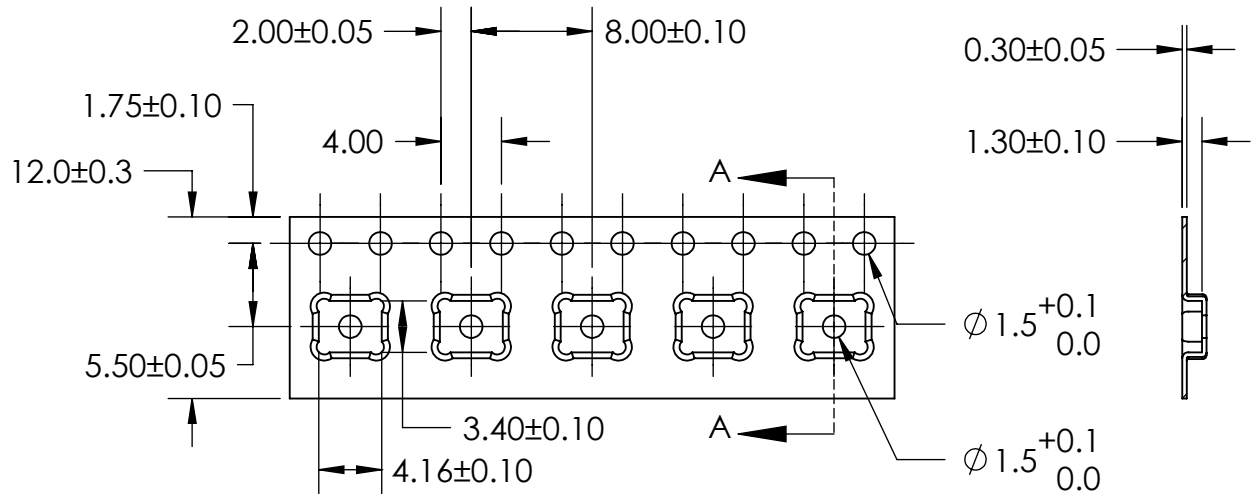
**11. PACKAGING DETAIL**

**COMPONENT  
ORIENTATION**

MODEL NUMBER	SUFFIX	REEL DIAMETER	QUANTITY PER REEL
SPU1410LR5H-QB	-7	13"	5,700

TAPE & REEL	PER EIA-481
LABEL	LABEL APPLIED TO EXTERNAL PACKAGE & DIRECT TO REEL.

**Note:**
**Dimensions are in millimeters unless otherwise specified.**



## 12. SOLDER REFLOW PROFILE

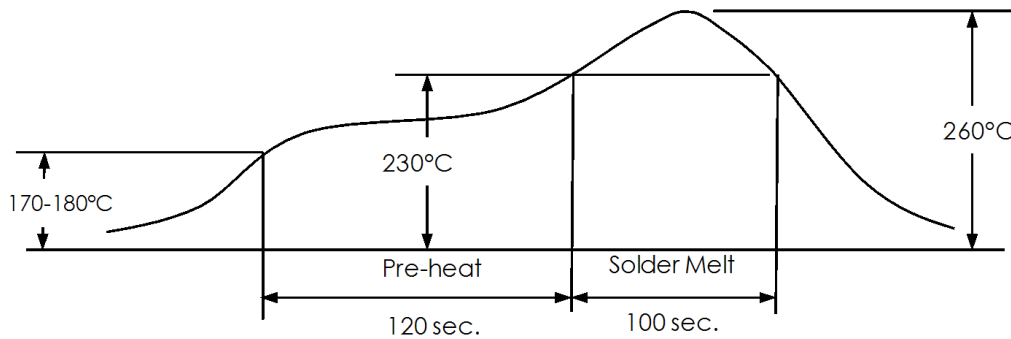

Stage	Temperature Profile	Time (maximum)
Pre-heat	170 ~ 180°C	120 sec.
Solder Melt	Above 230°C	100 sec.
Peak	260°C maximum	30 sec.

## 13. ADDITIONAL NOTES

- (A) Shelf life: Twelve (12) months when devices are to be stored in factory supplied, unopened ESD moisture sensitive bag under maximum environmental conditions of 30°C, 70% R.H.
- (B) MSL (moisture sensitivity level) Class 2a.
- (C) Do not pull a vacuum over port hole of the microphone. Pulling a vacuum over the port hole can damage the device.
- (D) Do not board wash after the reflow process. Board washing and cleaning agents can damage the device. Do not expose to ultrasonic processing or cleaning.
- (E) Do not brush board after the reflow process. Brushing the board with/without solvents can damage the device.
- (F) Do not insert any object in port hole of device at any time as this can damage the device.
- (G) Number of reflow - Recommend no more than 3 cycles.
- (H) Do not apply air pressure into the port hole. Air pressure over 30psi can damage the device.

## 14. RELIABILITY SPECIFICATIONS

**Note: After test conditions are performed, the sensitivity of the microphone shall not deviate more than 3dB from its initial value.**

Test	Description
Thermal Shock	100 cycles of air-air thermal shock from -40°C to +125°C with 15 minute soaks. (IEC 68-2-4)
High Temperature Storage	+105°C environment for 1,000 hours. (IEC 68-2-2 Test Ba)
Low Temperature Storage	-40°C environment for 1,000 hours. (IEC 68-2-2 Test Aa)
High Temperature Bias	+105°C environment while under bias for 1,000 hours. (IEC 68-2-2 Test Ba)
Low Temperature Bias	-40°C environment while under bias for 1,000 hours. (IEC 68-2-2 Test Aa)
Temperature / Humidity Bias	+85°C/85% R.H. environment while under bias for 1,000 hours. (JESD22-A101A-B)
Vibration	4 cycles lasting 12 minutes from 20 TO 2,000 Hz in X, Y and Z direction with peak acceleration of 20g. (MIL 883E, Method 2007.2, A)
Electrostatic Discharge	3 discharges at +/-8kV direct contact to lid when unit is grounded (IEC 61000-4-2) and 3 discharges at +/-2kV direct contact to I/O pins. (MIL 883E, Method 3015.7)
Reflow	5 reflow cycles with peak temperature of +260°C.
Mechanical Shock	3 pulses of 10,000g in the X, Y and Z direction. (IEC 68-2-27, Test Ea)

**15. SPECIFICATION REVISIONS**

<b>Revision</b>	<b>Detailed Specification Changes</b>	<b>Date</b>
<b>A</b>	<b>INITIAL RELEASE [C10113345]</b>	<b>02/14/12</b>

The information contained in this literature is based on our experience to date and is believed to be reliable and it is subject to change without notice. It is intended as a guide for use by persons having technical skill at their own discretion and risk. We do not guarantee favorable results or assume any liability in connection with its use. Dimensions contained herein are for reference purposes only. For specific dimensional requirements consult factory. This publication is not to be taken as a license to operate under, or recommendation to infringe any existing patents. This supersedes and voids all previous literature.