



4

3

2

1

THIS DRAWING IS UNPUBLISHED. RELEASED FOR PUBLICATION SEP ,2012.  
 © COPYRIGHT 2012 By Tyco Electronics Japan G.K. ALL RIGHTS RESERVED.

LOC	DIST	REVISIONS					
DW		P	LTR	DESCRIPTION	DATE	DWN	APVD
		-		SEE SHEET 1	-	-	-

1-2229293-1; AS SHOWN

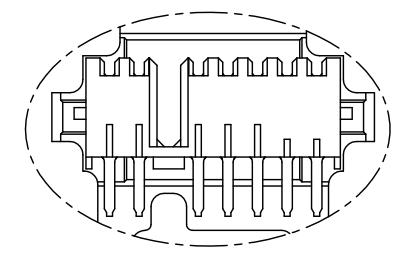
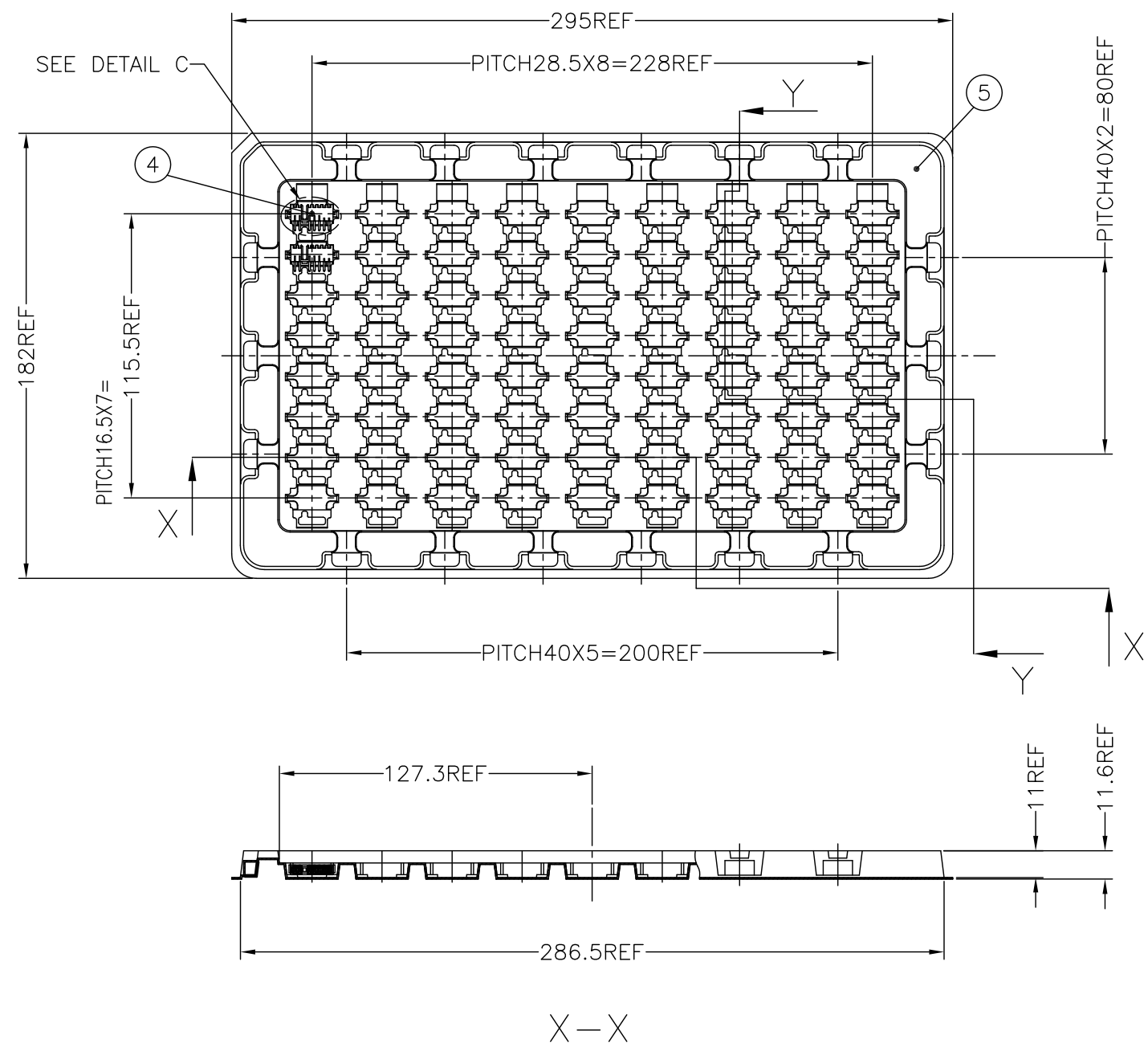

DETAIL C

PART NUMBER		
1-2229293-1		
1	TRAY	⑤
72	1-2229294-1	④
QTY REQD PER ASSY	COMPONENT NAME	NO.

THIS DRAWING IS A CONTROLLED DOCUMENT.		DWN		<b>STE</b> TE Connectivity	
DIMENSIONS: mm		CHK			
TOLERANCES UNLESS OTHERWISE SPECIFIED:		APVD		NAME	
0 PLC ± 0.3		PRODUCT SPEC		2mm PITCH BATTERY REC. ASSEMBLY 7POS. H=4.0	
1 PLC ± 0.3		APPLICATION SPEC		PACKING	
2 PLC ± 0.3		WEIGHT		SIZE	CAGE CODE
3 PLC ± 0.3		CUSTOMER DRAWING		A3	00779
4 PLC ± 0.3		SCALE		DRAWING NO	
ANGLES ± 3'		2:1		C-2229293	
FINISH		SHEET		RESTRICTED TO	
		2 OF 3		-	
		REV		B	

4

3

2

1

THIS DRAWING IS UNPUBLISHED. RELEASED FOR PUBLICATION SEP ,2012.  
 © COPYRIGHT 2012 By Tyco Electronics Japan G.K. ALL RIGHTS RESERVED.

LOC	DIST	REVISIONS			
P	LTR	DESCRIPTION	DATE	DWN	APVD
DW		-	SEE SHEET 1	-	-

# CONNECTOR W/O PACKING CONDITION

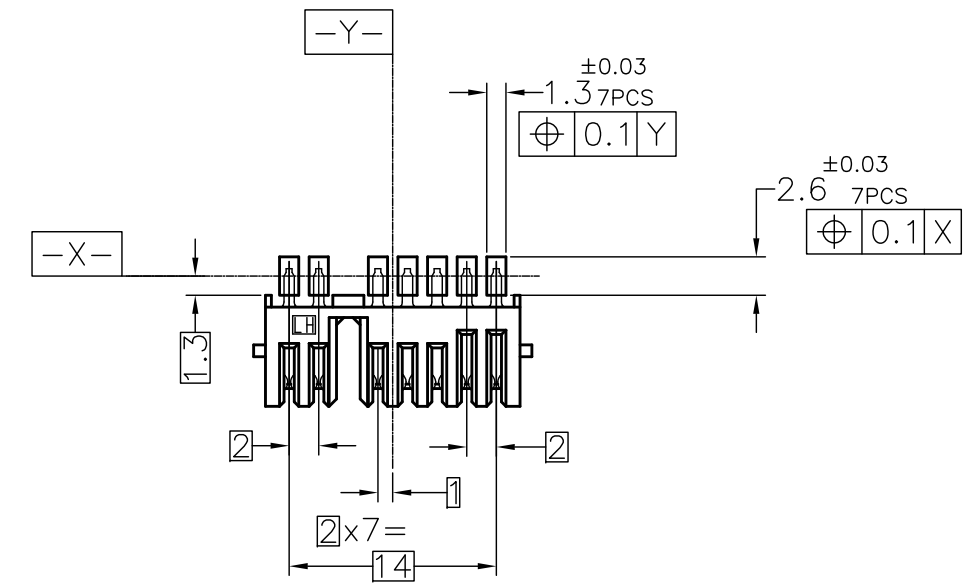
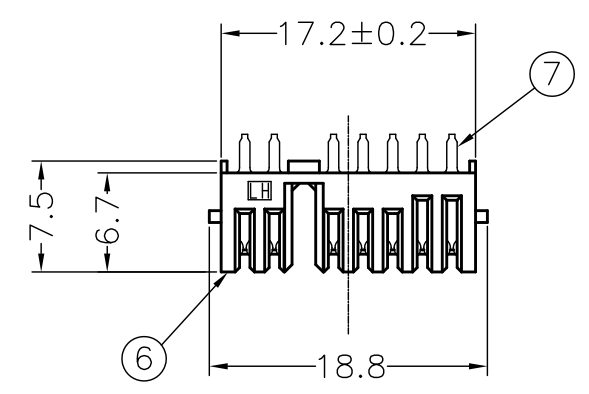
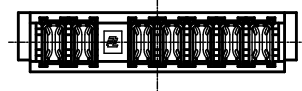

REFERENCE P.C.BOARD LAYOUT  
 P.C.BOARD THICKNESS : 0.8~1.2  
 (VIEW FROM CONNECTOR MOUNTING SIDE)

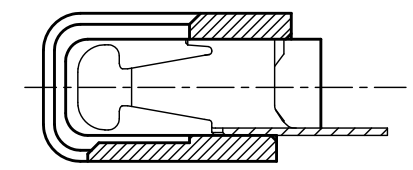
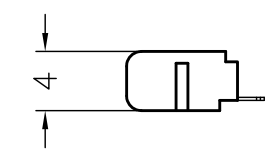
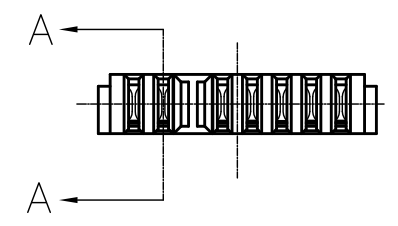

A-A  
 (SCALE 5:1)

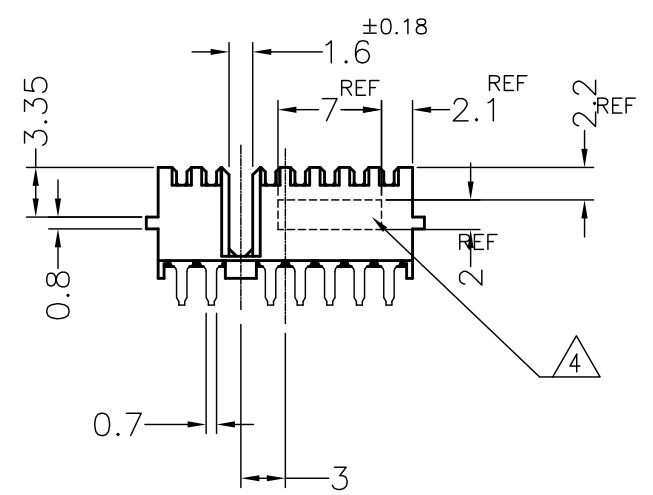

PART NUMBER			
1-2229294-1	2229294-1		
7	7	CONTACT	⑦
1	1	HOUSING	⑥
QTY REQD PER ASSY		COMPONENT NAME	NO.

THIS DRAWING IS A CONTROLLED DOCUMENT.		DWN		<b>STE</b> TE Connectivity	
DIMENSIONS: mm		CHK			
TOLERANCES UNLESS OTHERWISE SPECIFIED:		APVD		NAME	
0 PLC ± 0.3		PRODUCT SPEC		2mm PITCH BATTERY REC. ASSEMBLY 7POS. H=4.0	
1 PLC ± 0.3		APPLICATION SPEC		PACKING	
2 PLC ± 0.3		WEIGHT		SIZE	
3 PLC ± 0.3		0.7g		CAGE CODE	
4 PLC ± 0.3		CUSTOMER DRAWING		DRAWING NO	
ANGLES ± 3'		SCALE		RESTRICTED TO	
FINISH		2:1		A3 00779 C-2229293	
MATERIAL		SHEET		REV	
②		3 OF 3		B	