

# RF Power Field Effect Transistor

## N-Channel Enhancement-Mode Lateral MOSFET

Designed for CDMA base station applications with frequencies from 1930 to 1990 MHz. Can be used in Class AB and Class C for all typical cellular base station modulation formats.

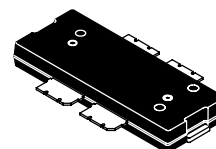
- Typical Single-Carrier W-CDMA Performance:  $V_{DD} = 28$  Volts,  $I_{DQ} = 1200$  mA,  $P_{out} = 36$  Watts Avg.,  $f = 1990$  MHz, IQ Magnitude Clipping, Channel Bandwidth = 3.84 MHz, Input Signal PAR = 7.5 dB @ 0.01% Probability on CCDF.
  - Power Gain — 18 dB
  - Drain Efficiency — 32%
  - Device Output Signal PAR — 6.1 dB @ 0.01% Probability on CCDF
  - ACPR @ 5 MHz Offset — -38.5 dBc in 3.84 MHz Channel Bandwidth
- Capable of Handling 10:1 VSWR, @ 32 Vdc, 1960 MHz, 120 Watts CW Output Power
- $P_{out}$  @ 1 dB Compression Point  $\approx 120$  W CW

### Features

- 100% PAR Tested for Guaranteed Output Power Capability
- Characterized with Series Equivalent Large-Signal Impedance Parameters
- Internally Matched for Ease of Use
- Integrated ESD Protection
- Greater Negative Gate-Source Voltage Range for Improved Class C Operation
- Designed for Digital Predistortion Error Correction Systems
- 225°C Capable Plastic Package
- RoHS Compliant
- In Tape and Reel. R1 Suffix = 500 Units, 44 mm Tape Width, 13 inch Reel.

**MRF7S19120NR1**

**1930-1990 MHz, 36 W AVG., 28 V  
 SINGLE W-CDMA  
 LATERAL N-CHANNEL  
 RF POWER MOSFET**



**CASE 1730-02  
 TO-270 WBL-4  
 PLASTIC**

**Table 1. Maximum Ratings**

Rating	Symbol	Value	Unit
Drain-Source Voltage	$V_{DSS}$	-0.5, +65	Vdc
Gate-Source Voltage	$V_{GS}$	-6.0, +10	Vdc
Operating Voltage	$V_{DD}$	32, +0	Vdc
Storage Temperature Range	$T_{stg}$	- 65 to +150	°C
Case Operating Temperature	$T_C$	150	°C
Operating Junction Temperature (1,2)	$T_J$	225	°C

**Table 2. Thermal Characteristics**

Characteristic	Symbol	Value (2,3)	Unit
Thermal Resistance, Junction to Case Case Temperature 81°C, 120 W CW Case Temperature 80°C, 36 W CW	$R_{\theta JC}$	0.43 0.51	°C/W

1. Continuous use at maximum temperature will affect MTTF.
2. MTTF calculator available at <http://www.freescale.com/rf>. Select Software & Tools/Development Tools/Calculators to access MTTF calculators by product.
3. Refer to AN1955, *Thermal Measurement Methodology of RF Power Amplifiers*. Go to <http://www.freescale.com/rf>. Select Documentation/Application Notes - AN1955.

**Table 3. ESD Protection Characteristics**

Test Methodology	Class
Human Body Model (per JESD22-A114)	2 (Minimum)
Machine Model (per EIA/JESD22-A115)	A (Minimum)
Charge Device Model (per JESD22-C101)	III (Minimum)

**Table 4. Moisture Sensitivity Level**

Test Methodology	Rating	Package Peak Temperature	Unit
Per JESD22-A113, IPC/JEDEC J-STD-020	3	260	°C

**Table 5. Electrical Characteristics** ( $T_A = 25^\circ\text{C}$  unless otherwise noted)

Characteristic	Symbol	Min	Typ	Max	Unit
----------------	--------	-----	-----	-----	------

**Off Characteristics**

Zero Gate Voltage Drain Leakage Current ( $V_{DS} = 65\text{ Vdc}$ , $V_{GS} = 0\text{ Vdc}$ )	$I_{DSS}$	—	—	10	$\mu\text{Adc}$
Zero Gate Voltage Drain Leakage Current ( $V_{DS} = 28\text{ Vdc}$ , $V_{GS} = 0\text{ Vdc}$ )	$I_{DSS}$	—	—	1	$\mu\text{Adc}$
Gate-Source Leakage Current ( $V_{GS} = 5\text{ Vdc}$ , $V_{DS} = 0\text{ Vdc}$ )	$I_{GSS}$	—	—	1	$\mu\text{Adc}$

**On Characteristics**

Gate Threshold Voltage ( $V_{DS} = 10\text{ Vdc}$ , $I_D = 270\ \mu\text{Adc}$ )	$V_{GS(th)}$	1.2	2	2.7	Vdc
Gate Quiescent Voltage ( $V_{DD} = 28\text{ Vdc}$ , $I_D = 1200\text{ mAdc}$ , Measured in Functional Test)	$V_{GS(Q)}$	2	2.7	3.5	Vdc
Drain-Source On-Voltage ( $V_{GS} = 10\text{ Vdc}$ , $I_D = 2.7\text{ Adc}$ )	$V_{DS(on)}$	0.15	0.275	0.35	Vdc

**Dynamic Characteristics (1)**

Reverse Transfer Capacitance ( $V_{DS} = 28\text{ Vdc} \pm 30\text{ mV(rms)ac}$ @ 1 MHz, $V_{GS} = 0\text{ Vdc}$ )	$C_{rss}$	—	1.65	—	pF
Output Capacitance ( $V_{DS} = 28\text{ Vdc} \pm 30\text{ mV(rms)ac}$ @ 1 MHz, $V_{GS} = 0\text{ Vdc}$ )	$C_{oss}$	—	600	—	pF
Input Capacitance ( $V_{DS} = 28\text{ Vdc}$ , $V_{GS} = 0\text{ Vdc} \pm 30\text{ mV(rms)ac}$ @ 1 MHz)	$C_{iss}$	—	1.03	—	pF

**Functional Tests** (In Freescale Test Fixture, 50 ohm system)  $V_{DD} = 28\text{ Vdc}$ ,  $I_{DQ} = 1200\text{ mA}$ ,  $P_{out} = 36\text{ W Avg.}$ ,  $f = 1990\text{ MHz}$ , Single-Carrier W-CDMA, IQ Magnitude Clipping, Input Signal PAR = 7.5 dB @ 0.01% Probability on CCDF. ACPR measured in 3.84 MHz Channel Bandwidth @  $\pm 5\text{ MHz}$  Offset.

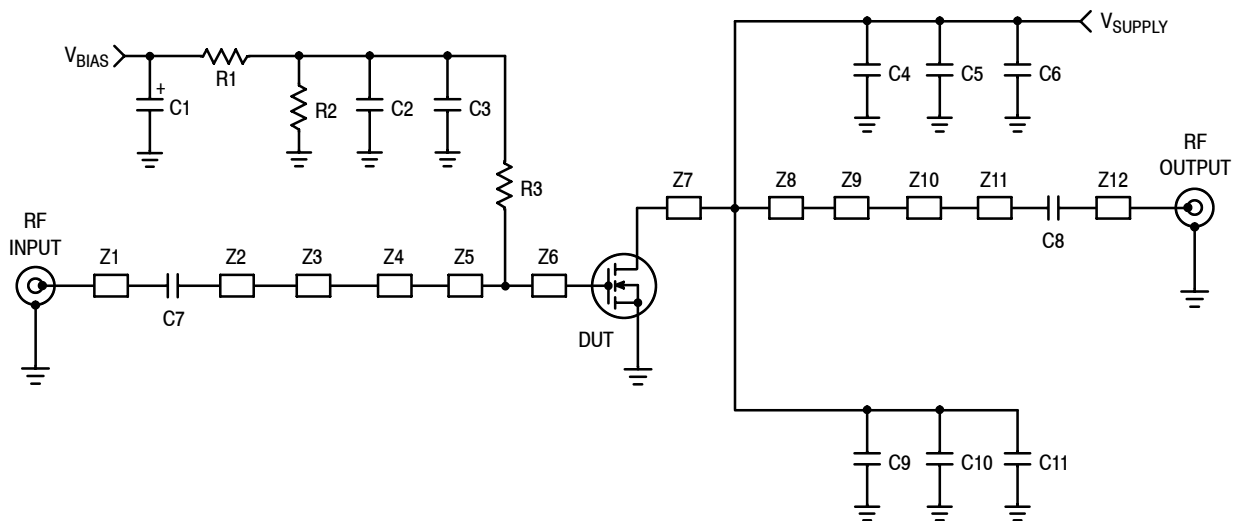
Power Gain	$G_{ps}$	16.5	18	19.5	dB
Drain Efficiency	$\eta_D$	30	32	36	%
Output Peak-to-Average Ratio @ 0.01% Probability on CCDF	PAR	5.7	6.1	—	dB
Adjacent Channel Power Ratio	ACPR	—	-38.5	-35.5	dBc
Input Return Loss	IRL	—	-10	-7	dB

1. Part internally matched both on input and output.

(continued)

**Table 5. Electrical Characteristics** ( $T_A = 25^\circ\text{C}$  unless otherwise noted) (continued)

Characteristic	Symbol	Min	Typ	Max	Unit
<b>Typical Performances</b> (In Freescale Test Fixture, 50 ohm system) $V_{DD} = 28\text{ Vdc}$ , $I_{DQ} = 1200\text{ mA}$ , 1930–1990 MHz Bandwidth					
Video Bandwidth @ 120 W PEP $P_{out}$ where $IM3 = -30\text{ dBc}$ (Tone Spacing from 100 kHz to VBW) $\Delta IMD3 = IMD3 @ \text{VBW frequency} - IMD3 @ 100\text{ kHz} < 1\text{ dBc}$ (both sidebands)	VBW	—	20	—	MHz
Gain Flatness in 60 MHz Bandwidth @ $P_{out} = 36\text{ W Avg.}$	$G_F$	—	0.495	—	dB
Average Deviation from Linear Phase in 60 MHz Bandwidth @ $P_{out} = 120\text{ W CW}$	$\Phi$	—	0.914	—	°
Average Group Delay @ $P_{out} = 120\text{ W CW}$ , $f = 1960\text{ MHz}$	Delay	—	1.98	—	ns
Part-to-Part Insertion Phase Variation @ $P_{out} = 120\text{ W CW}$ , $f = 1960\text{ MHz}$ , Six Sigma Window	$\Delta\Phi$	—	33.9	—	°
Gain Variation over Temperature ( $-30^\circ\text{C}$ to $+85^\circ\text{C}$ )	$\Delta G$	—	0.016	—	dB/°C
Output Power Variation over Temperature ( $-30^\circ\text{C}$ to $+85^\circ\text{C}$ )	$\Delta P_{1dB}$	—	0.009	—	dB/°C

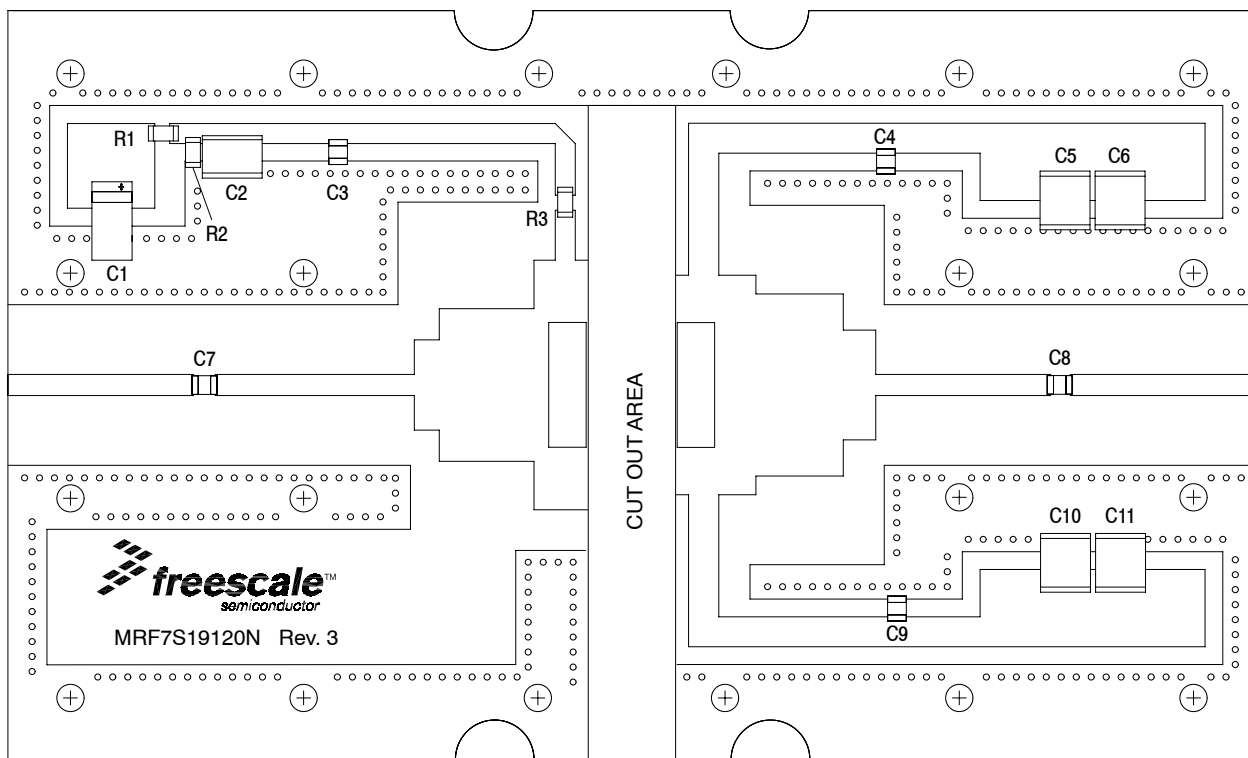


Z1	0.084" x 0.744" Microstrip	Z8	0.880" x 0.210" Microstrip
Z2	0.084" x 0.797" Microstrip	Z9	0.730" x 0.350" Microstrip
Z3	0.362" x 0.100" Microstrip	Z10	0.440" x 0.130" Microstrip
Z4	0.612" x 0.380" Microstrip	Z11	0.084" x 0.700" Microstrip
Z5	1.000" x 0.125" Microstrip	Z12	0.084" x 0.743" Microstrip
Z6	1.000" x 0.090" Microstrip	PCB	Arlon CuClad 250GX-0300-55-22, 0.030", $\epsilon_r = 2.55$
Z7	0.880" x 0.111" Microstrip		

**Figure 1. MRF7S19120NR1 Test Circuit Schematic**

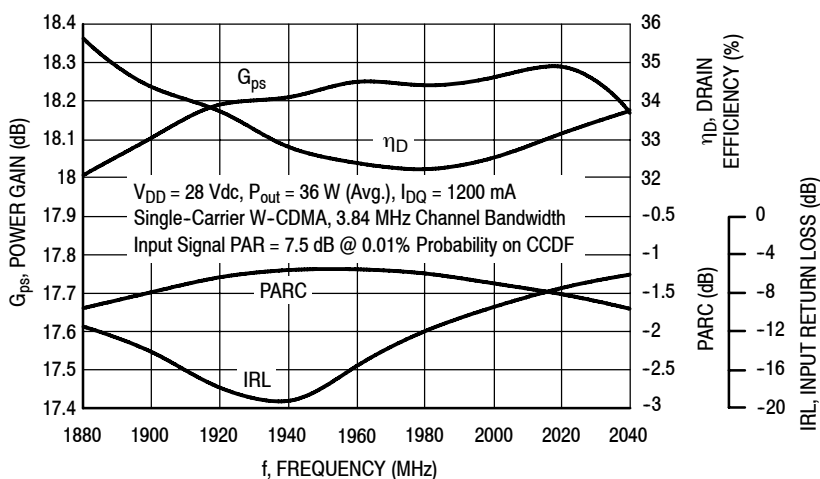
**Table 6. MRF7S19120NR1 Test Circuit Component Designations and Values**

Part	Description	Part Number	Manufacturer
C1	10 $\mu$ F, 35 V Tantalum Capacitor	T491D106K035AT	Kemet
C2	0.01 $\mu$ F Chip Capacitor	C1825C103J1GAC	Kemet
C3, C4, C8, C9	5.1 pF Chip Capacitors	ATC100B5R1BT500XT	ATC
C5, C6, C10, C11	10 $\mu$ F Chip Capacitors	GRM55DR61H106KA88L	Murata
C7	11 pF Chip Capacitor	ATC100B110BT500XT	ATC
R1	1 K $\Omega$ , 1/4 W Chip Resistor	CRCW12061001FKEA	Vishay
R2	10 K $\Omega$ , 1/4 W Chip Resistor	CRCW12061002FKEA	Vishay
R3	10 $\Omega$ , 1/4 W Chip Resistor	CRCW120610R0FKEA	Vishay

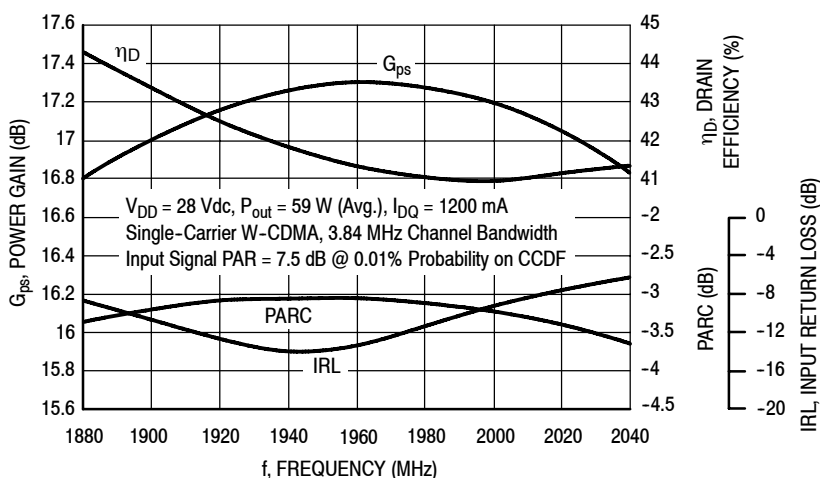


**Figure 2. MRF7S19120NR1 Test Circuit Component Layout**

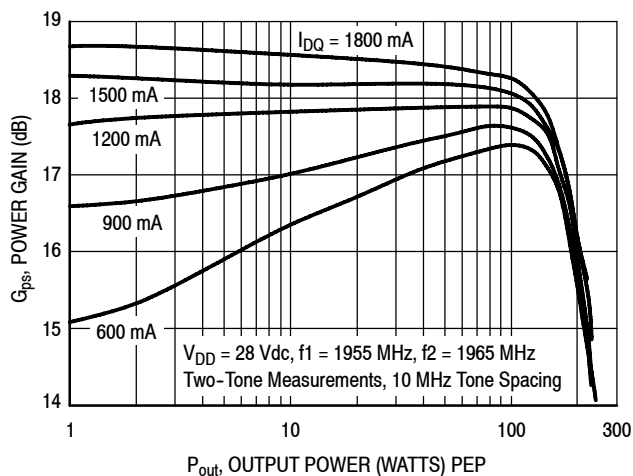
### TYPICAL CHARACTERISTICS



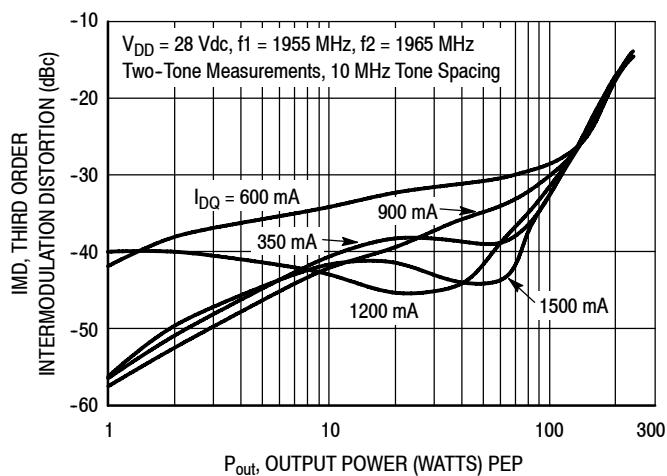
**Figure 3. Output Peak-to-Average Ratio Compression (PARC) Broadband Performance @  $P_{out} = 36$  Watts Avg.**



**Figure 4. Output Peak-to-Average Ratio Compression (PARC) Broadband Performance @  $P_{out} = 59$  Watts Avg.**

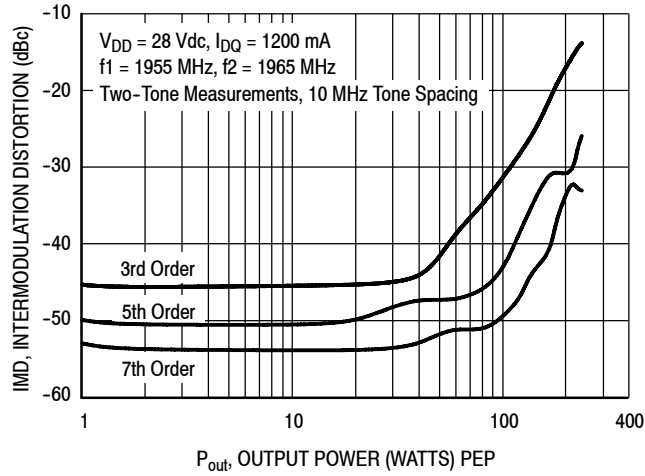


**Figure 5. Two-Tone Power Gain versus Output Power**

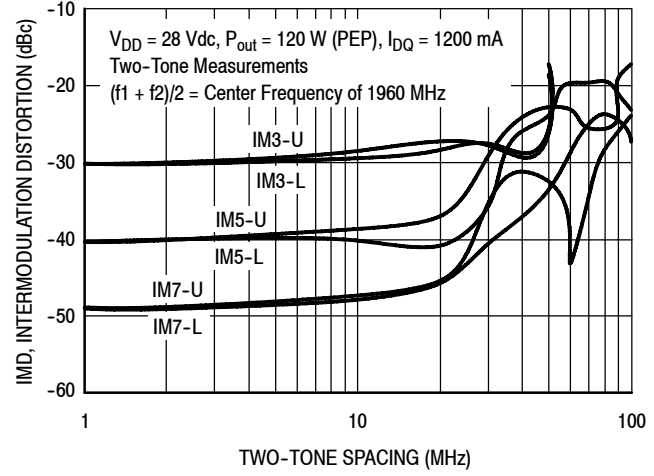


**Figure 6. Third Order Intermodulation Distortion versus Output Power**

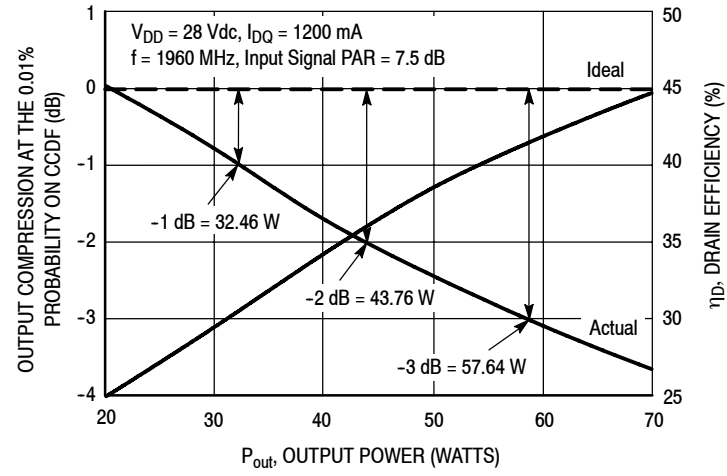
### TYPICAL CHARACTERISTICS



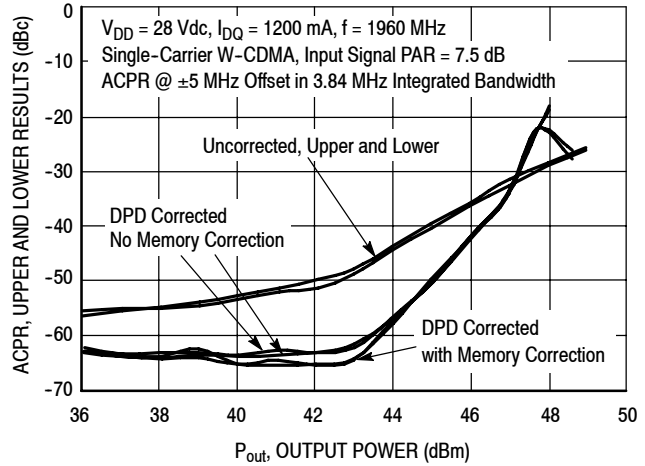
**Figure 7. Intermodulation Distortion Products versus Output Power**



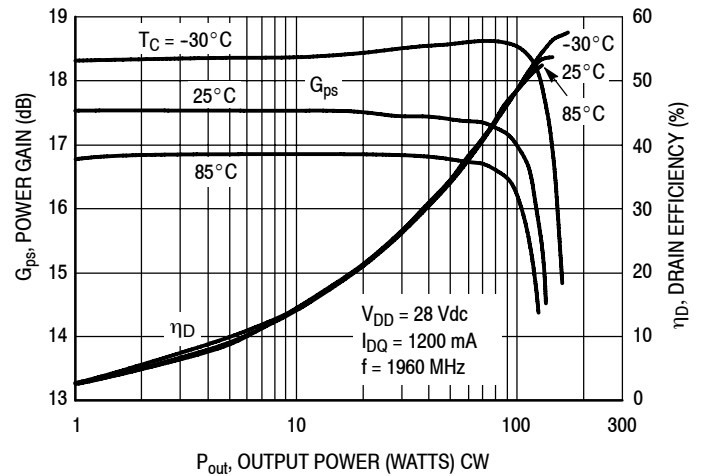
**Figure 8. Intermodulation Distortion Products versus Tone Spacing**



**Figure 9. Output Peak-to-Average Ratio Compression (PARC) versus Output Power**



**Figure 10. Digital Predistortion Correction versus ACPR and Output Power**



**Figure 11. Power Gain and Drain Efficiency versus CW Output Power**

### TYPICAL CHARACTERISTICS

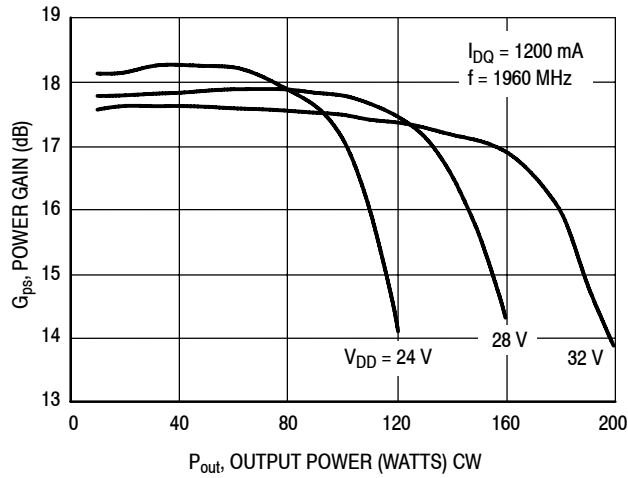


Figure 12. Power Gain versus Output Power

### W-CDMA TEST SIGNAL

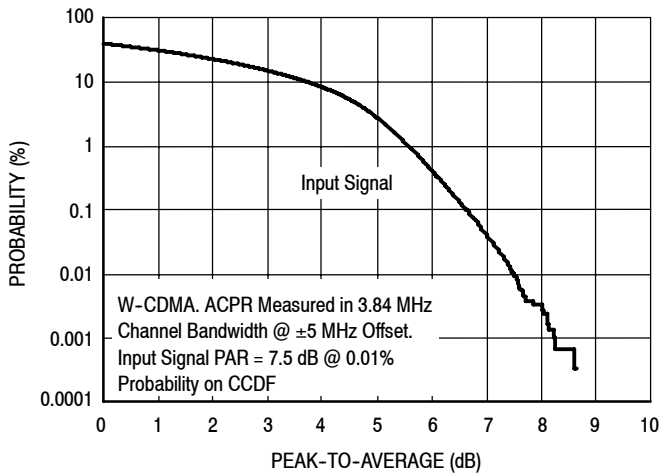


Figure 13. CCDF W-CDMA IQ Magnitude Clipping, Single-Carrier Test Signal

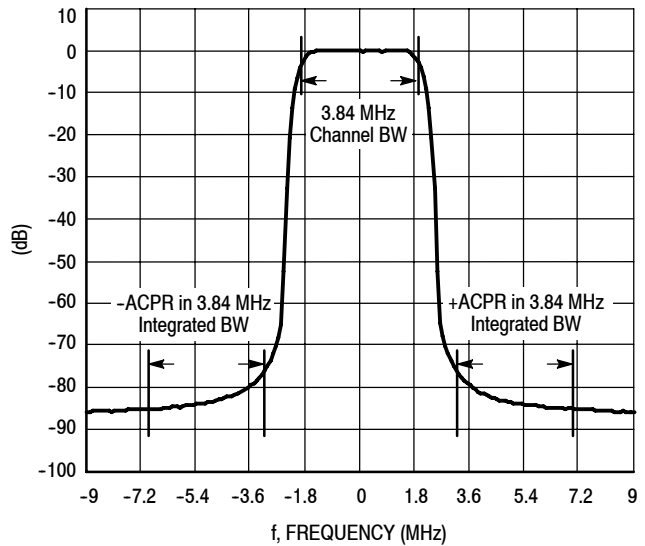
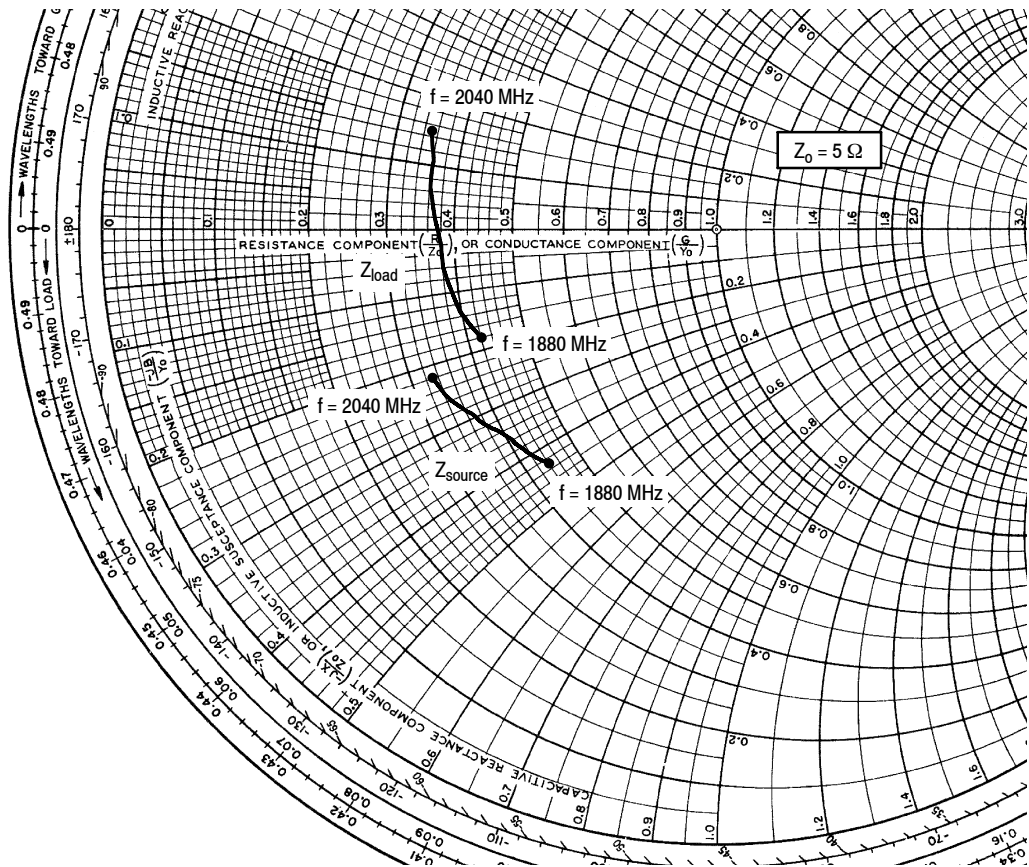


Figure 14. Single-Carrier W-CDMA Spectrum





$V_{DD} = 28 \text{ Vdc}$ ,  $I_{DQ} = 1200 \text{ mA}$ ,  $P_{out} = 36 \text{ W Avg.}$

f MHz	$Z_{source}$ $\Omega$	$Z_{load}$ $\Omega$
1880	$2.195 - j2.157$	$2.091 - j0.905$
1900	$2.122 - j2.019$	$2.012 - j0.712$
1920	$2.054 - j1.880$	$1.957 - j0.515$
1940	$1.979 - j1.747$	$1.912 - j0.312$
1960	$1.922 - j1.623$	$1.887 - j0.089$
1980	$1.858 - j1.500$	$1.848 + j0.121$
2000	$1.793 - j1.380$	$1.819 + j0.327$
2020	$1.717 - j1.255$	$1.789 + j0.540$
2040	$1.645 - j1.112$	$1.761 + j0.756$

$Z_{source}$  = Test circuit impedance as measured from gate to ground.

$Z_{load}$  = Test circuit impedance as measured from drain to ground.

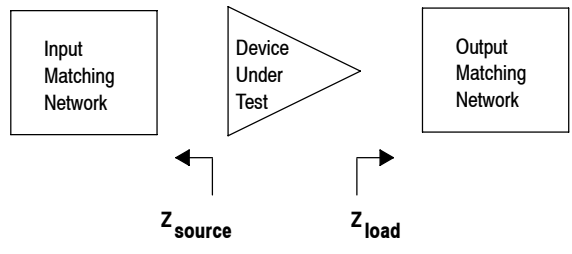
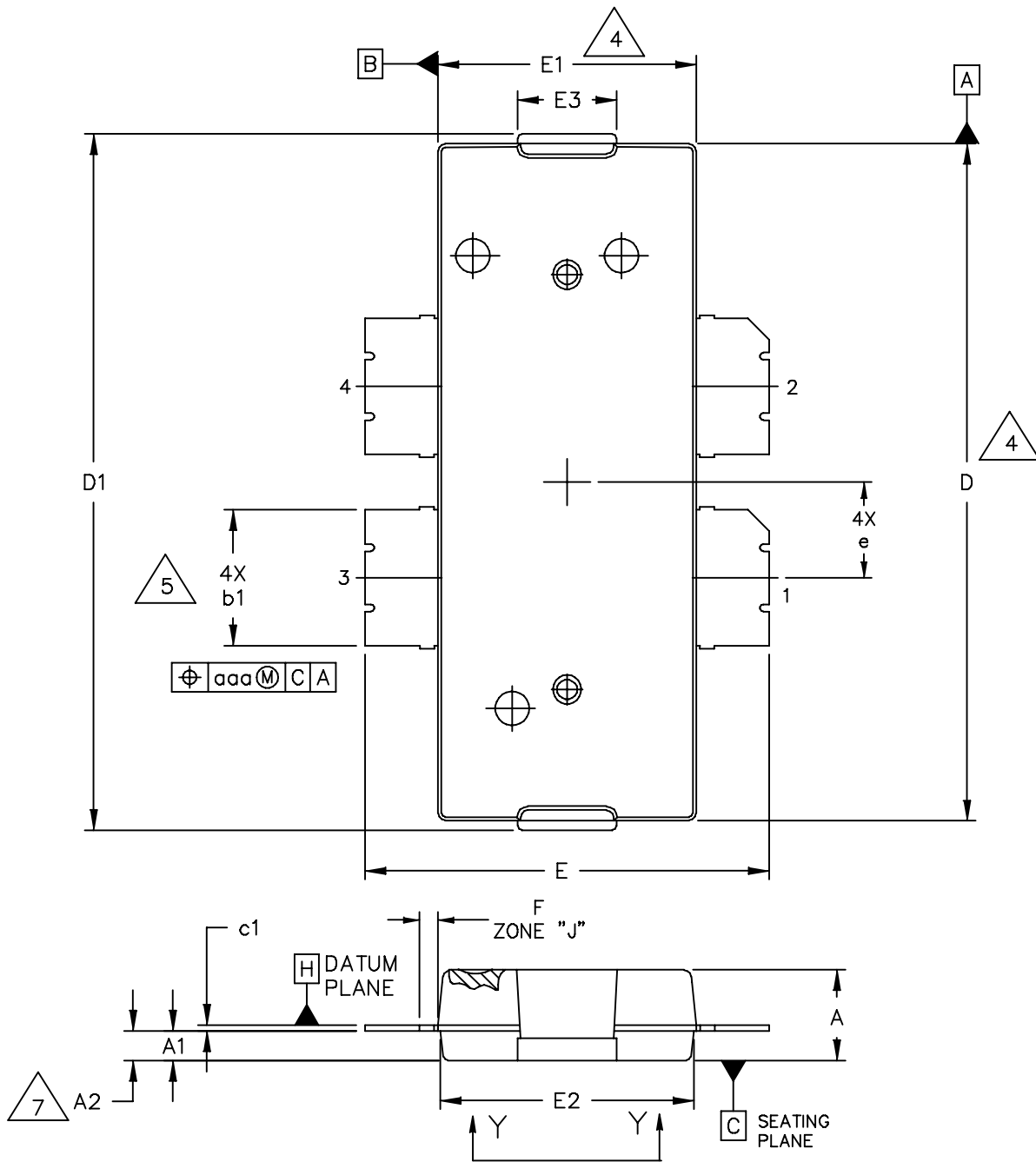
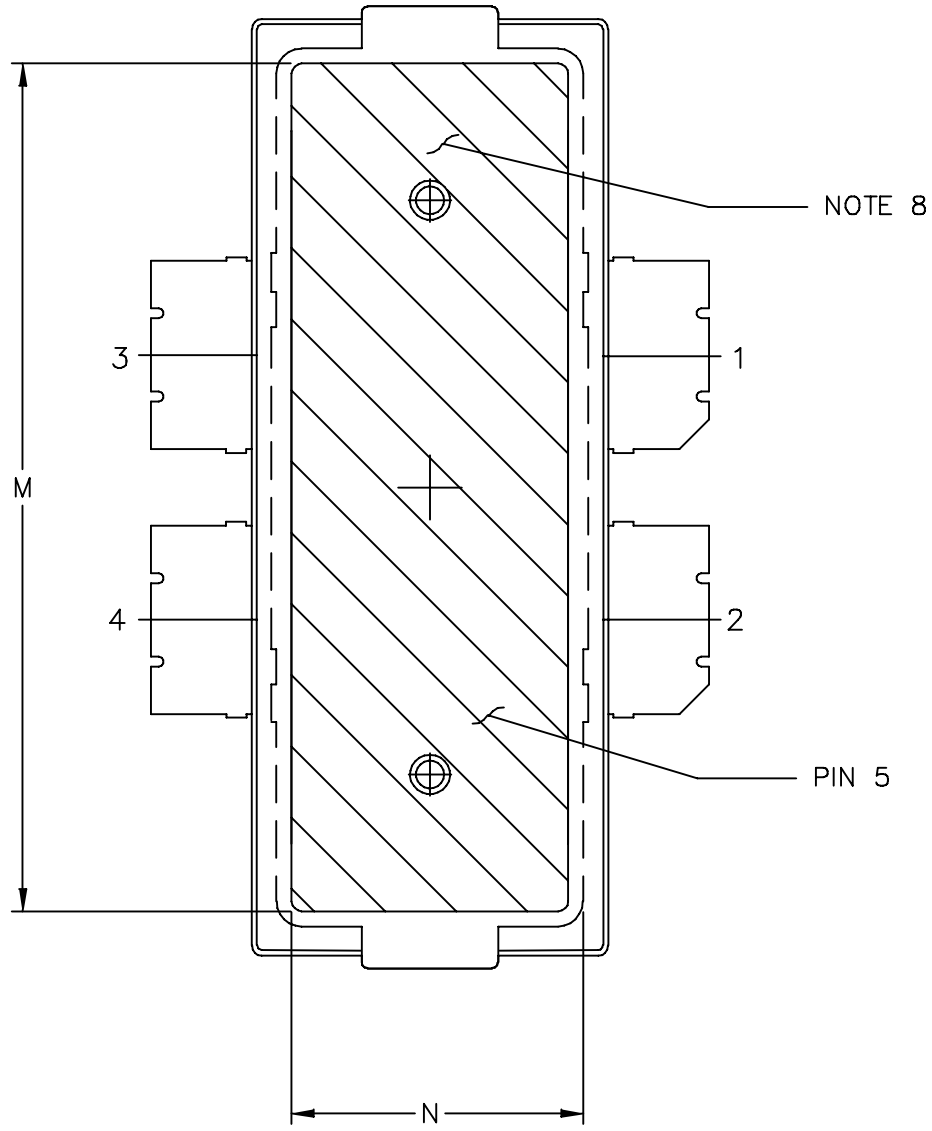


Figure 15. Series Equivalent Source and Load Impedance

PACKAGE DIMENSIONS



© FREESCALE SEMICONDUCTOR, INC. ALL RIGHTS RESERVED.	MECHANICAL OUTLINE	PRINT VERSION NOT TO SCALE
TITLE: TO-270 WIDEBODY LONG 4 LEAD (STRAIGHT LEAD)	DOCUMENT NO: 98ASA10882D	REV: A
	CASE NUMBER: 1730-02	30 JUL 2007
	STANDARD: NON-JEDEC	



VIEW Y-Y

© FREESCALE SEMICONDUCTOR, INC. ALL RIGHTS RESERVED.	MECHANICAL OUTLINE	PRINT VERSION NOT TO SCALE	
TITLE: TO-270 WIDEBODY LONG 4 LEAD (STRAIGHT LEAD)	DOCUMENT NO: 98ASA10882D	REV: A	
	CASE NUMBER: 1730-02	30 JUL 2007	
	STANDARD: NON-JEDEC		

NOTES:

1. CONTROLLING DIMENSION: INCH
2. INTERPRET DIMENSIONS AND TOLERANCES PER ASME Y14.5M-1994.
3. DATUM PLANE -H- IS LOCATED AT THE TOP OF LEAD AND IS COINCIDENT WITH THE LEAD WHERE THE LEAD EXITS THE PLASTIC BODY AT THE TOP OF THE PARTING LINE.
4. DIMENSIONS DO NOT INCLUDE MOLD PROTRUSION. ALLOWABLE PROTRUSION IS .006 PER SIDE. THESE DIMENSIONS DO INCLUDE MOLD MISMATCH AND ARE DETERMINED AT DATUM PLANE -H-.
5. DIMENSIONS DOES NOT INCLUDE DAMBAR PROTRUSION. ALLOWABLE DAMBAR PROTRUSION SHALL BE .005 TOTAL IN EXCESS OF THIS DIMENSION AT MAXIMUM MATERIAL CONDITION.
6. DATUMS -A- AND -B- TO BE DETERMINED AT DATUM PLANE -H-.
7. DIMENSION APPLIES WITHIN ZONE "J" ONLY.
8. HATCHING REPRESENTS THE EXPOSED AREA OF THE HEAT SLUG.

PIN 1 - DRAIN    PIN 2 - DRAIN  
 PIN 3 - GATE    PIN 4 - GATEC  
 PIN 5 - SOURCE

DIM	INCH		MILLIMETER		DIM	INCH		MILLIMETER	
	MIN	MAX	MIN	MAX		MIN	MAX	MIN	MAX
A	.122	.128	3.12	3.23	b1	.184	.190	4.67	4.83
A1	.039	.043	0.99	1.09	c1	.007	.011	0.18	0.28
A2	.040	.042	1.02	1.07	e	.1315 BSC		3.34 BSC	
D	.928	.932	23.57	23.67	aaa	.004		0.10	
D1	.954	.958	24.23	24.33					
E	.551	.559	14	14.2					
E1	.353	.357	8.97	9.07					
E2	.346	.350	8.79	8.89					
E3	.132	.140	3.35	3.56					
F	.025 BSC		0.64 BSC						
M	.800	---	20.32	---					
N	.270	---	6.86	---					

© FREESCALE SEMICONDUCTOR, INC. ALL RIGHTS RESERVED.		MECHANICAL OUTLINE		PRINT VERSION NOT TO SCALE	
TITLE: TO-270 WIDEBODY LONG 4 LEAD (STRAIGHT LEAD)			DOCUMENT NO: 98ASA10882D		REV: A
			CASE NUMBER: 1730-02		30 JUL 2007
			STANDARD: NON-JEDEC		

## PRODUCT DOCUMENTATION AND SOFTWARE

Refer to the following documents and software to aid your design process.

### Application Notes

- AN1907: Solder Reflow Attach Method for High Power RF Devices in Plastic Packages
- AN1955: Thermal Measurement Methodology of RF Power Amplifiers
- AN3789: Clamping of High Power RF Transistors and RFICs in Over-Molded Plastic Packages

### Engineering Bulletins

- EB212: Using Data Sheet Impedances for RF LDMOS Devices

### Software

- Electromigration MTTF Calculator

For Software, do a Part Number search at <http://www.freescale.com>, and select the “Part Number” link. Go to the Software & Tools tab on the part’s Product Summary page to download the respective tool.

## REVISION HISTORY

The following table summarizes revisions to this document.

Revision	Date	Description
0	Sept. 2007	<ul style="list-style-type: none"> <li>• Initial Release of Data Sheet</li> </ul>
1	Jan. 2009	<ul style="list-style-type: none"> <li>• Updated Fig. 14, CCDF W-CDMA 3GPP, Test Model 1, 64 DPCH, 50% Clipping, Single-Carrier Test Signal, to better represent production test signal, p. 8</li> <li>• Updated Fig. 16, Series Equivalent Source and Load Impedance, large signal <math>Z_{source}</math> impedance parameters to better reflect measured values, p. 9</li> </ul>
2	Dec. 2009	<ul style="list-style-type: none"> <li>• Updated Charge Device Model ESD from Class IV to III to reflect actual Qual Report results, p. 2</li> <li>• Fig. 14, CCDF W-CDMA IQ Magnitude Clipping, Single-Carrier Test Signal and Fig. 15, Single-Carrier W-CDMA Spectrum updated to show the undistorted input test signal, p. 8</li> <li>• Added AN1907, Solder Reflow Attach Method for High Power RF Devices in Plastic Packages and AN3789, Clamping of High Power RF Transistors and RFICs in Over-Molded Plastic Packages to Product Documentation, Application Notes, p. 13</li> <li>• Added Electromigration MTTF Calculator availability to Product Software, p. 13</li> </ul>
3	Mar. 2011	<ul style="list-style-type: none"> <li>• Modified data sheet to reflect RF Test Reduction described in Product and Process Change Notification number, PCN13628, p. 1, 2</li> <li>• Fig. 13, MTTF versus Junction Temperature removed, p. 8. Refer to the device’s MTTF Calculator available at <a href="http://freescale.com/RFpower">freescale.com/RFpower</a>. Go to Design Resources &gt; Software and Tools.</li> </ul>

## **How to Reach Us:**

### **Home Page:**

[www.freescale.com](http://www.freescale.com)

### **Web Support:**

<http://www.freescale.com/support>

### **USA/Europe or Locations Not Listed:**

Freescale Semiconductor, Inc.  
Technical Information Center, EL516  
2100 East Elliot Road  
Tempe, Arizona 85284  
1-800-521-6274 or +1-480-768-2130  
[www.freescale.com/support](http://www.freescale.com/support)

### **Europe, Middle East, and Africa:**

Freescale Halbleiter Deutschland GmbH  
Technical Information Center  
Schatzbogen 7  
81829 Muenchen, Germany  
+44 1296 380 456 (English)  
+46 8 52200080 (English)  
+49 89 92103 559 (German)  
+33 1 69 35 48 48 (French)  
[www.freescale.com/support](http://www.freescale.com/support)

### **Japan:**

Freescale Semiconductor Japan Ltd.  
Headquarters  
ARCO Tower 15F  
1-8-1, Shimo-Meguro, Meguro-ku,  
Tokyo 153-0064  
Japan  
0120 191014 or +81 3 5437 9125  
[support.japan@freescale.com](mailto:support.japan@freescale.com)

### **Asia/Pacific:**

Freescale Semiconductor China Ltd.  
Exchange Building 23F  
No. 118 Jianguo Road  
Chaoyang District  
Beijing 100022  
China  
+86 10 5879 8000  
[support.asia@freescale.com](mailto:support.asia@freescale.com)

### **For Literature Requests Only:**

Freescale Semiconductor Literature Distribution Center  
1-800-441-2447 or +1-303-675-2140  
Fax: +1-303-675-2150  
[LDCForFreescaleSemiconductor@hibbertgroup.com](mailto:LDCForFreescaleSemiconductor@hibbertgroup.com)

Information in this document is provided solely to enable system and software implementers to use Freescale Semiconductor products. There are no express or implied copyright licenses granted hereunder to design or fabricate any integrated circuits or integrated circuits based on the information in this document.

Freescale Semiconductor reserves the right to make changes without further notice to any products herein. Freescale Semiconductor makes no warranty, representation or guarantee regarding the suitability of its products for any particular purpose, nor does Freescale Semiconductor assume any liability arising out of the application or use of any product or circuit, and specifically disclaims any and all liability, including without limitation consequential or incidental damages. "Typical" parameters that may be provided in Freescale Semiconductor data sheets and/or specifications can and do vary in different applications and actual performance may vary over time. All operating parameters, including "Typicals", must be validated for each customer application by customer's technical experts. Freescale Semiconductor does not convey any license under its patent rights nor the rights of others. Freescale Semiconductor products are not designed, intended, or authorized for use as components in systems intended for surgical implant into the body, or other applications intended to support or sustain life, or for any other application in which the failure of the Freescale Semiconductor product could create a situation where personal injury or death may occur. Should Buyer purchase or use Freescale Semiconductor products for any such unintended or unauthorized application, Buyer shall indemnify and hold Freescale Semiconductor and its officers, employees, subsidiaries, affiliates, and distributors harmless against all claims, costs, damages, and expenses, and reasonable attorney fees arising out of, directly or indirectly, any claim of personal injury or death associated with such unintended or unauthorized use, even if such claim alleges that Freescale Semiconductor was negligent regarding the design or manufacture of the part.

Freescale™ and the Freescale logo are trademarks of Freescale Semiconductor, Inc. All other product or service names are the property of their respective owners.

© Freescale Semiconductor, Inc. 2007, 2009, 2011. All rights reserved.