

Standard Heat Sinks

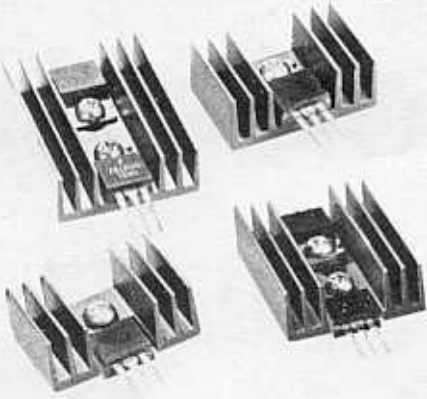

Material.... 6063-T5 Aluminum
Finish..... Black Anodize

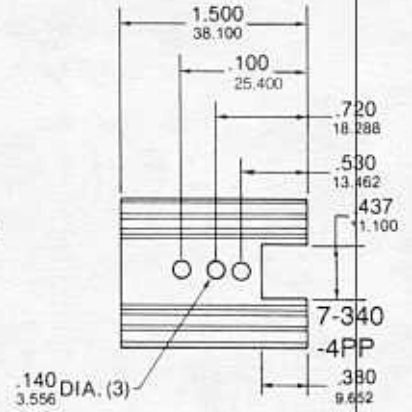
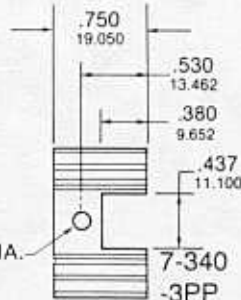
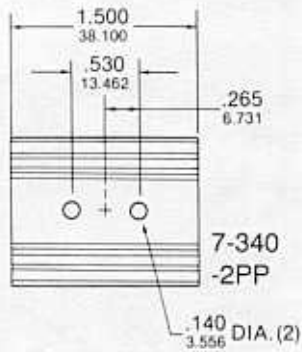
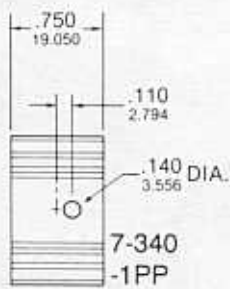
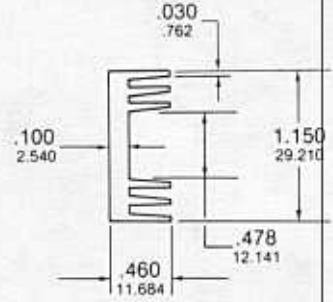
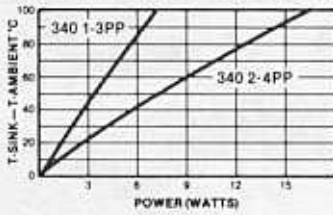

7-340-1,-2,-3,-4

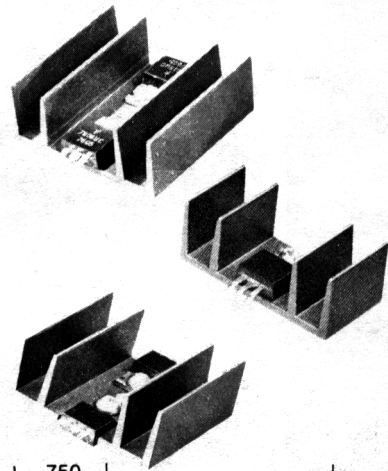

Material.... 6063-T5 Aluminum
Finish..... Black Anodize

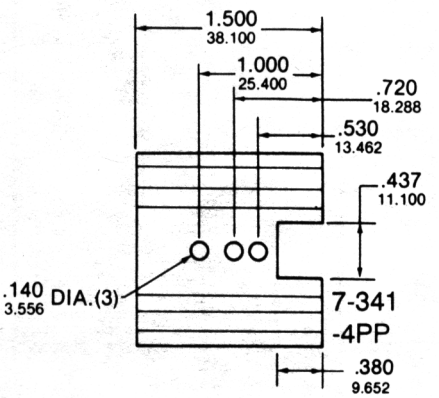
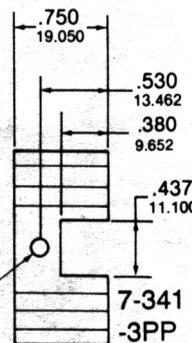
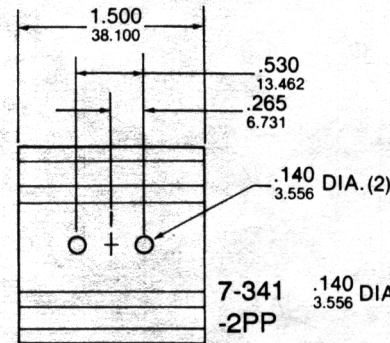
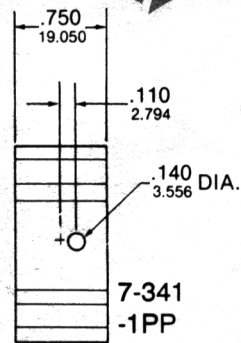
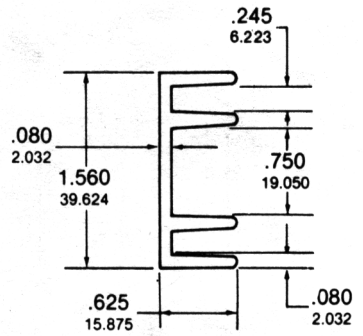
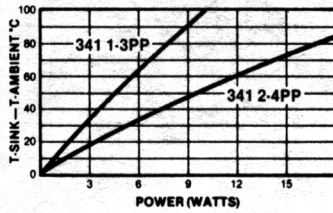

7-341-1,-2,-3,-4

Low Power