



## Typical Applications

Prescaler for DC to X band PLL applications:

- Satellite communication systems
- Fiber optic
- Point-to-point and point-to-multi-point radios
- VSAT

## Features

- Ultra low SSB phase noise: -148 dBc/Hz
- Wide bandwidth
- Output power: 3 dBm
- Single DC supply: +5V
- S8G SMT package

## Functional Diagram

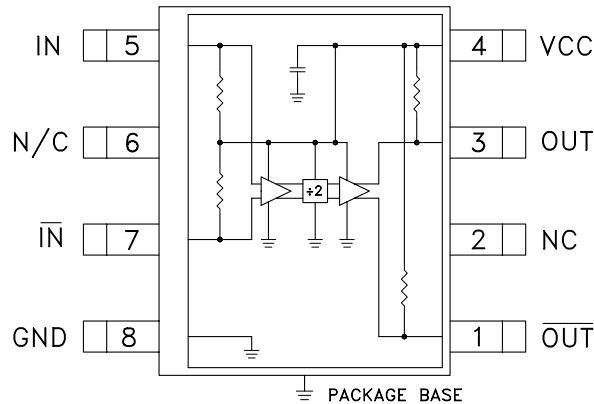

## General Description

The HMC361S8G & HMC361S8GE are low noise divide-by-2 static dividers with InGaP GaAs HBT technology in 8 lead surface mount plastic packages. This device operates from DC (with a square wave input) to 10 GHz input frequency with a single +5V DC supply. The low additive SSB phase noise of -148 dBc/Hz at 100 kHz offset helps the user maintain good system noise performance.

## Electrical Specifications, $T_A = +25^\circ\text{C}$ , 50 Ohm System, $V_{CC} = 5V$

Parameter	Conditions	Min.	Typ.	Max.	Units
Input frequency	Sine wave input. [1][2]	0.4		10	GHz
Input power range	$F_{in} = 0.4\text{ GHz to }1\text{ GHz}$	-5		+10	dBm
	$F_{in} = 1\text{ GHz to }8\text{ GHz}$	-15		+10	dBm
	$F_{in} = 8\text{ GHz to }10\text{ GHz}$	-10		+2	dBm
Output power	$F_{in} = 6\text{ GHz}$	0	3		dBm
	$F_{in} = 10\text{ GHz}$	-6			dBm
Reverse leakage	Both RF outputs terminated		45		dB
SSB phase noise (100 kHz offset)	$P_{in} = 0\text{ dBm}, F_{in} = 6\text{ GHz}$		-148		dBc/Hz
Output transition time	$P_{in} = 0\text{ dBm}, F_{out} = 882\text{ MHz}$		100		ps
Supply current ( $I_{CC}$ )			83		mA

[1] Divider will operate down to near DC for square-wave input signal.

[2] For stable operation without an input signal, refer to Analog Devices Application Note, "Frequency Divider Operation & Compensation with No Input Signal."

# HMC361S8G\* PRODUCT PAGE QUICK LINKS

Last Content Update: 02/23/2017

---

## COMPARABLE PARTS

View a parametric search of comparable parts.

## EVALUATION KITS

- HMC361S8G Evaluation Board

## DOCUMENTATION

### Data Sheet

- HMC361S8G Data Sheet

## TOOLS AND SIMULATIONS

- HMC361S8G S-Parameters

## REFERENCE MATERIALS

### Quality Documentation

- HMC Legacy PCN: S## and S##E packages - Relocation of pre-existing production equipment to new building
- Package/Assembly Qualification Test Report: Plastic Encapsulated SOIC (QTR: 02018 REV: 01)
- PCN: MS, QS, SOT, SOIC packages - Sn/Pb plating vendor change
- Semiconductor Qualification Test Report: GaAs HBT-A (QTR: 2013-00228)

## DESIGN RESOURCES

- HMC361S8G Material Declaration
- PCN-PDN Information
- Quality And Reliability
- Symbols and Footprints

## DISCUSSIONS

View all HMC361S8G EngineerZone Discussions.

## SAMPLE AND BUY

Visit the product page to see pricing options.

## TECHNICAL SUPPORT

Submit a technical question or find your regional support number.

## DOCUMENT FEEDBACK

Submit feedback for this data sheet.



**Input Sensitivity Window,  $T = 25\text{ }^{\circ}\text{C}$**

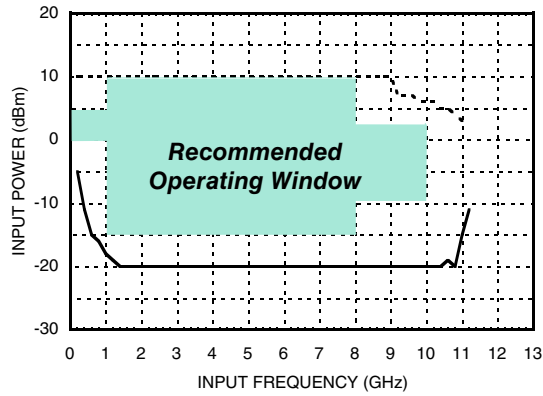

**Input Sensitivity Window vs. Temperature**

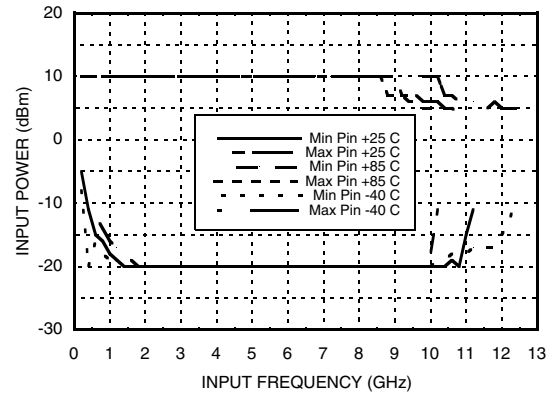

**Output Power vs. Temperature**

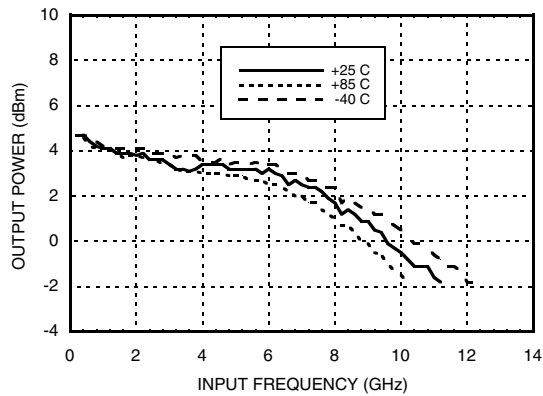

**Residual Phase Noise Performance,  $P_{in} = 0\text{ dBm}$ ,  $T = 25\text{ }^{\circ}\text{C}$**

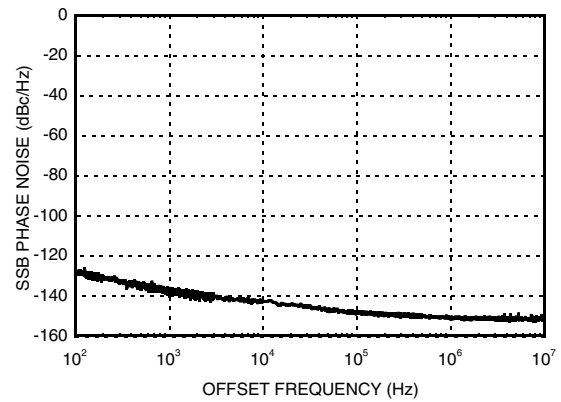

**Output Harmonic Content,  $P_{in} = 0\text{ dBm}$ ,  $T = 25\text{ }^{\circ}\text{C}$**

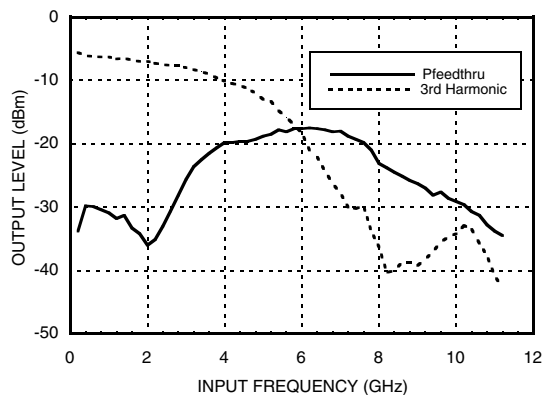

**Reverse Leakage,  $P_{in} = 0\text{ dBm}$ ,  $T = 25\text{ }^{\circ}\text{C}$**

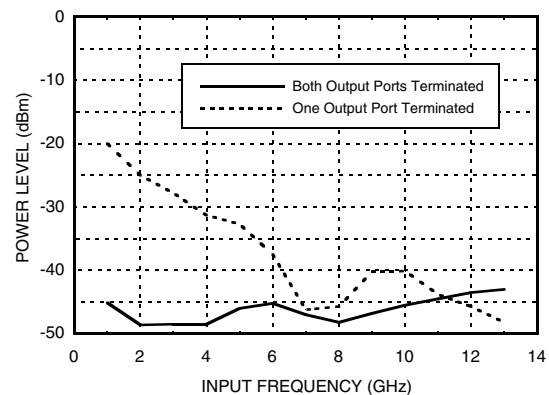

Information furnished by Analog Devices is believed to be accurate and reliable. However, no responsibility is assumed by Analog Devices for its use, nor for any infringements of patents or other rights of third parties that may result from its use. Specifications subject to change without notice. No license is granted by implication or otherwise under any patent or patent rights of Analog Devices. Trademarks and registered trademarks are the property of their respective owners.

For price, delivery, and to place orders: Analog Devices, Inc., One Technology Way, P.O. Box 9106, Norwood, MA 02062-9106 Phone: 781-329-4700 • Order online at [www.analog.com](http://www.analog.com) Application Support: Phone: 1-800-ANALOG-D



**Output Voltage Waveform,**  
*Pin = 0 dBm, Fout = 882 MHz, T = 25 °C*

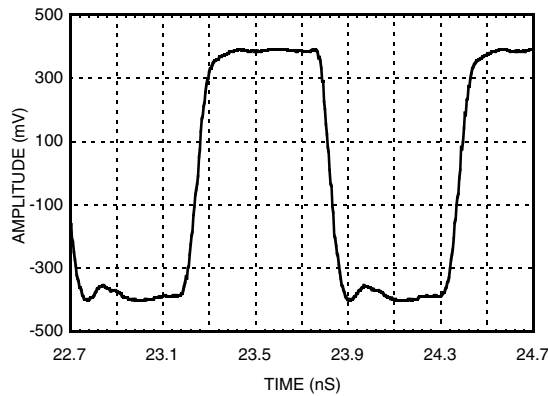

### Absolute Maximum Ratings

RF input (Vcc = +5V)	+13 dBm
Vcc	+5.5V
VLogic	Vcc -1.6V to Vcc -1.2V
Junction temperature (T <sub>J</sub> )	135 °C
Continuous P <sub>diss</sub> (T = 85 °C) (derate 15.9 mW/°C above 85 °C)	0.79 W
Thermal resistance (R <sub>TH</sub> ) (junction to ground paddle)	63 °C/W
Storage temperature	-65 °C to +150 °C
Operating temperature	-40 °C to +85 °C

### Typical Supply Current vs. Vcc

Vcc (V)	Icc (mA)
4.75	74
5.0	83
5.25	89

Note: Divider will operate over full voltage range shown above



**ELECTROSTATIC SENSITIVE DEVICE  
OBSERVE HANDLING PRECAUTIONS**

### Outline Drawing

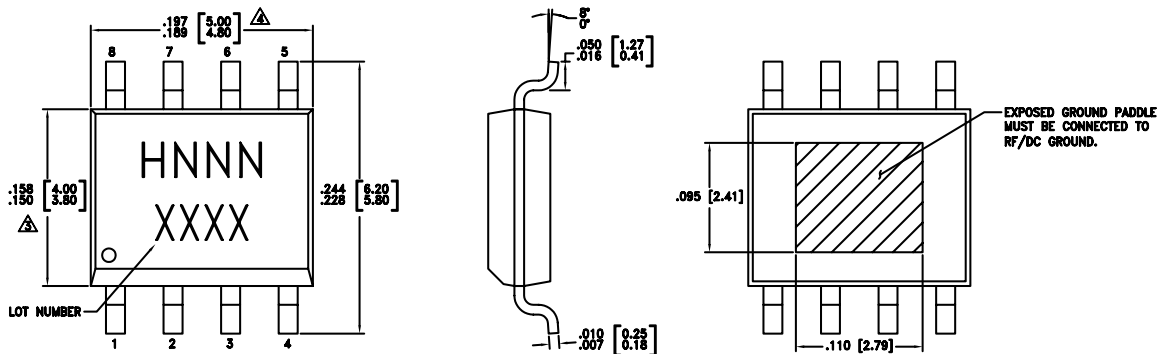

**NOTES:**

1. LEADFRAME MATERIAL: COPPER ALLOY
2. DIMENSIONS ARE IN INCHES [MILLIMETERS].
3. DIMENSION DOES NOT INCLUDE MOLDFLASH OF 0.15 mm PER SIDE.
4. DIMENSION DOES NOT INCLUDE MOLDFLASH OF 0.25 mm PER SIDE.
5. ALL GROUND LEADS AND GROUND PADDLE MUST BE SOLDERED TO PCB RF GROUND.

### Package Information

Part Number	Package Body Material	Lead Finish	MSL Rating	Package Marking [3]
HMC361S8G	Low stress injection molded plastic	Sn/Pb solder	MSL1 [1]	H361 XXXX
HMC361S8GE	RoHS-compliant low stress injection molded plastic	100% matte Sn	MSL1 [2]	H361 XXXX



[1] Max peak reflow temperature of 235 °C

[2] Max peak reflow temperature of 260 °C

[3] 4-digit lot number XXXX

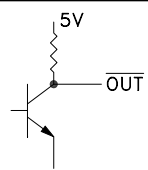
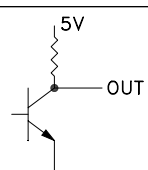
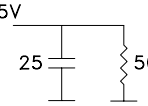
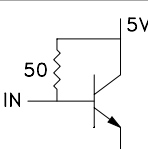
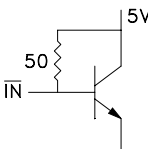

### Pin Description

Pin Number	Function	Description	Interface Schematic
1	$\overline{\text{OUT}}$	Divided output 180° out of phase with pin 3 and must be DC blocked	
2, 6	N/C	N/C or ground	
3	OUT	Divided output, DC block required	
4	VCC	Supply voltage 5V ± 0.25V.	
5	IN	RF input must be DC blocked.	
7	$\overline{\text{IN}}$	RF input 180° out of phase with pin 5, DC block required for differential operation or A/C ground for single ended applications	
8	GND	Ground backside of package has exposed metal ground slug which must be connected to ground.	



**Evaluation PCB**

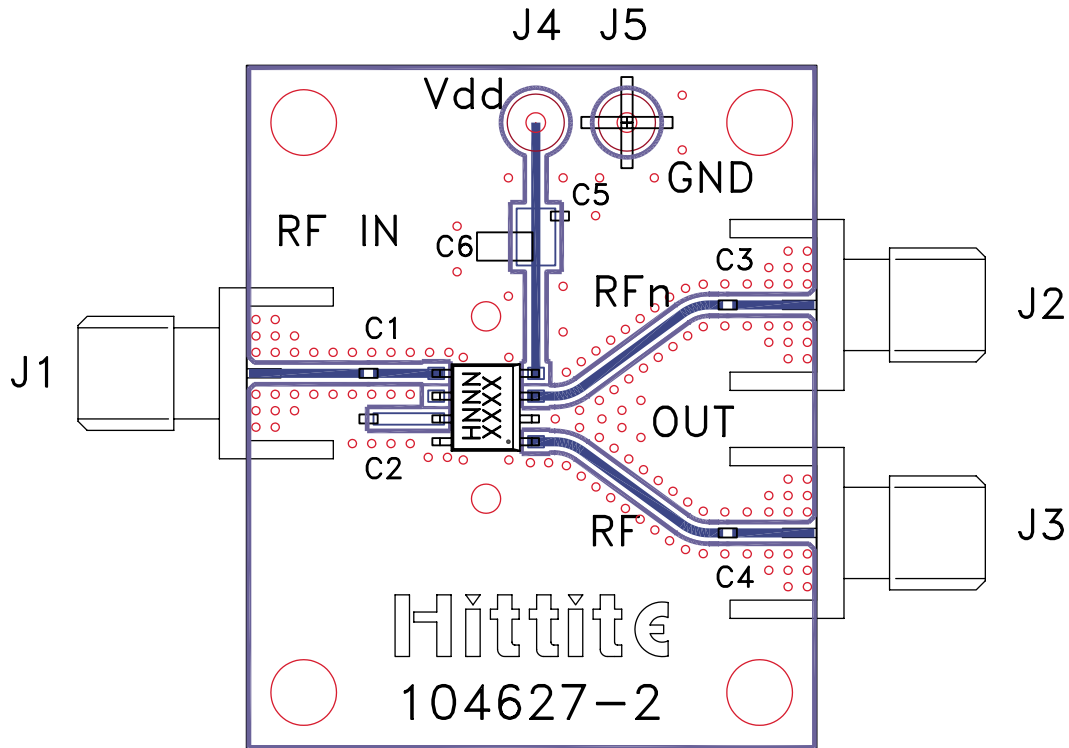

**List of Materials for Evaluation PCB 104631 [1]**

Item	Description
J1 - J3	PCB mount SMA RF connector
C1 - C4	100 pF capacitor, 0402 pkg.
C5	1000 pF capacitor, 0603 pkg.
C6	10 $\mu$ F tantalum capacitor
U1	HMC361S8G / HMC361S8GE divide-by-2
PCB [2]	104627 eval board

[1] Reference this number when ordering complete evaluation PCB

[2] Circuit board material: Rogers 4350

The circuit board used in the application should use RF circuit design techniques. Signal lines should have 50  $\Omega$  impedance while the package ground leads and backside ground slug should be connected directly to the ground plane similar to that shown. A sufficient number of via holes should be used to connect the top and bottom ground planes. The evaluation circuit board shown is available from Hittite upon request. This evaluation board is designed for single ended input testing. J2 and J3 provide differential output signals.

**Application Circuit**

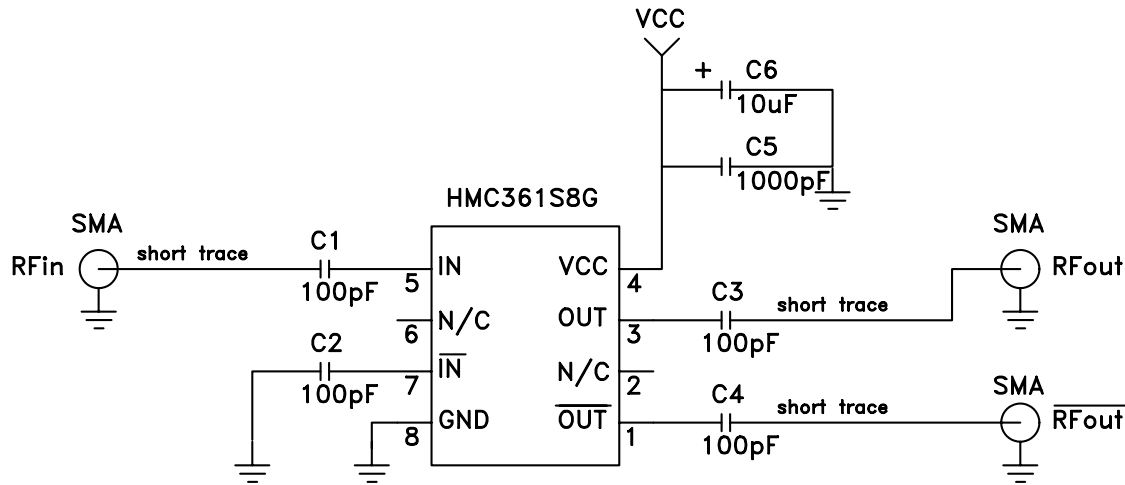

Information furnished by Analog Devices is believed to be accurate and reliable. However, no responsibility is assumed by Analog Devices for its use, nor for any infringements of patents or other rights of third parties that may result from its use. Specifications subject to change without notice. No license is granted by implication or otherwise under any patent or patent rights of Analog Devices. Trademarks and registered trademarks are the property of their respective owners.

For price, delivery, and to place orders: Analog Devices, Inc., One Technology Way, P.O. Box 9106, Norwood, MA 02062-9106 Phone: 781-329-4700 • Order online at [www.analog.com](http://www.analog.com) Application Support: Phone: 1-800-ANALOG-D