

BATT-14AAAPACK

Configurable AAA Battery Pack for KIT33771TPLEVB,
KIT33771SPIEVB, and KIT33772ASP1EVB



Figure 1. BATT-14AAAPACK



Contents

1	Important Notice	3
2	Getting Started	4
3	Understanding the Battery Pack	5
4	Getting to Know the Hardware	6
5	Configuring the Hardware	9
6	Schematic	11
7	Board Layout	12
8	Board Bill of Materials	13
9	References	14
10	Revision History	15

1 Important Notice

Freescale provides the enclosed product(s) under the following conditions:

This evaluation kit is intended for use of ENGINEERING DEVELOPMENT OR EVALUATION PURPOSES ONLY. It is provided as a sample IC pre-soldered to a printed circuit board to make it easier to access inputs, outputs, and supply terminals. This evaluation board may be used with any development system or other source of I/O signals by simply connecting it to the host MCU or computer board via off-the-shelf cables. This evaluation board is not a Reference Design and is not intended to represent a final design recommendation for any particular application. Final device in an application will be heavily dependent on proper printed circuit board layout and heat sinking design as well as attention to supply filtering, transient suppression, and I/O signal quality.

The goods provided may not be complete in terms of required design, marketing, and or manufacturing related protective considerations, including product safety measures typically found in the end product incorporating the goods. Due to the open construction of the product, it is the user's responsibility to take any and all appropriate precautions with regard to electrostatic discharge. In order to minimize risks associated with the customers applications, adequate design and operating safeguards must be provided by the customer to minimize inherent or procedural hazards. For any safety concerns, contact Freescale sales and technical support services.

Should this evaluation kit not meet the specifications indicated in the kit, it may be returned within 30 days from the date of delivery and will be replaced by a new kit.

Freescale reserves the right to make changes without further notice to any products herein. Freescale makes no warranty, representation or guarantee regarding the suitability of its products for any particular purpose, nor does Freescale assume any liability arising out of the application or use of any product or circuit, and specifically disclaims any and all liability, including without limitation consequential or incidental damages. "Typical" parameters can and do vary in different applications and actual performance may vary over time. All operating parameters, including "Typical", must be validated for each customer application by customer's technical experts.

Freescale does not convey any license under its patent rights nor the rights of others. Freescale products are not designed, intended, or authorized for use as components in systems intended for surgical implant into the body, or other applications intended to support or sustain life, or for any other application in which the failure of the Freescale product could create a situation where personal injury or death may occur.

Should the Buyer purchase or use Freescale products for any such unintended or unauthorized application, the Buyer shall indemnify and hold Freescale and its officers, employees, subsidiaries, affiliates, and distributors harmless against all claims, costs, damages, and expenses, and reasonable attorney fees arising out of, directly or indirectly, any claim of personal injury or death associated with such unintended or unauthorized use, even if such claim alleges Freescale was negligent regarding the design or manufacture of the part. Freescale™ and the Freescale logo are trademarks of Freescale Semiconductor, Inc. All other product or service names are the property of their respective owners. © Freescale Semiconductor, Inc. 2015

2 Getting Started

2.1 Kit Contents/Packing List

The **BATT-14AAAPACK** contents include:

- Assembled and tested battery pack board with housing
- 34-pin ribbon cable
- Warranty card

2.2 Jump Start

Freescale's analog product development boards help to easily evaluate Freescale products. These tools support analog mixed signal and power solutions including monolithic ICs using proven high-volume SMARTMOS mixed signal technology, and system-in-package devices utilizing power, SMARTMOS and MCU dies. Freescale products enable longer battery life, smaller form factor, component count reduction, ease of design, lower system cost and improved performance in powering state of the art systems.

- Go to www.freescale.com/BATT-14AAAPACK
- Review your Tool Summary Page
- Look for



Jump Start Your Design

- Download documents, software and other information

Once the files are downloaded, review the user guide in the bundle. The user guide includes setup instructions, BOM and schematics. Jump start bundles are available on each tool summary page with the most relevant and current information. The information includes everything needed for design.

3 Understanding the Battery Pack

3.1 BATT-14AAAPACK Overview

The BATT-14AAAPACK is a 3-cell to 14-cell configurable battery pack designed to work in conjunction with evaluation boards such as the KIT33771TPLEVB, the KIT33771SPIEBV, or the KIT33772ASP1EBV. It offers a compact and easily accessible standard battery platform that connects directly to the evaluation boards through a 34-pin ribbon cable. The BATT-14AAAPACK thereby eliminates the need for designing additional hardware to connect with a series of batteries.

The BATT-14AAAPACK includes 14 battery holders (standard AAA format, also known as LR3) connected in series, an optional current sense resistor, configuration jumpers, and a 1.3mm jack for charging.

3.2 Battery Pack Features

The BATT-14AAAPACK features

- 14 AAA battery holders
- 34-pin header compatible with KIT33771TPLEVB, KIT33771SPIEBV, and KIT33772ASP1EBV
- 1.3mm jack serial charging jack (to be used only with proper serial charger and rechargeable batteries)
- 2mm banana connectors
- 0.1 Ω resistor for current measurement
- Current measurement configuration jumper
- MC33771/MC33772 configuration jumper
- Protection fuse

3.3 Block Diagram

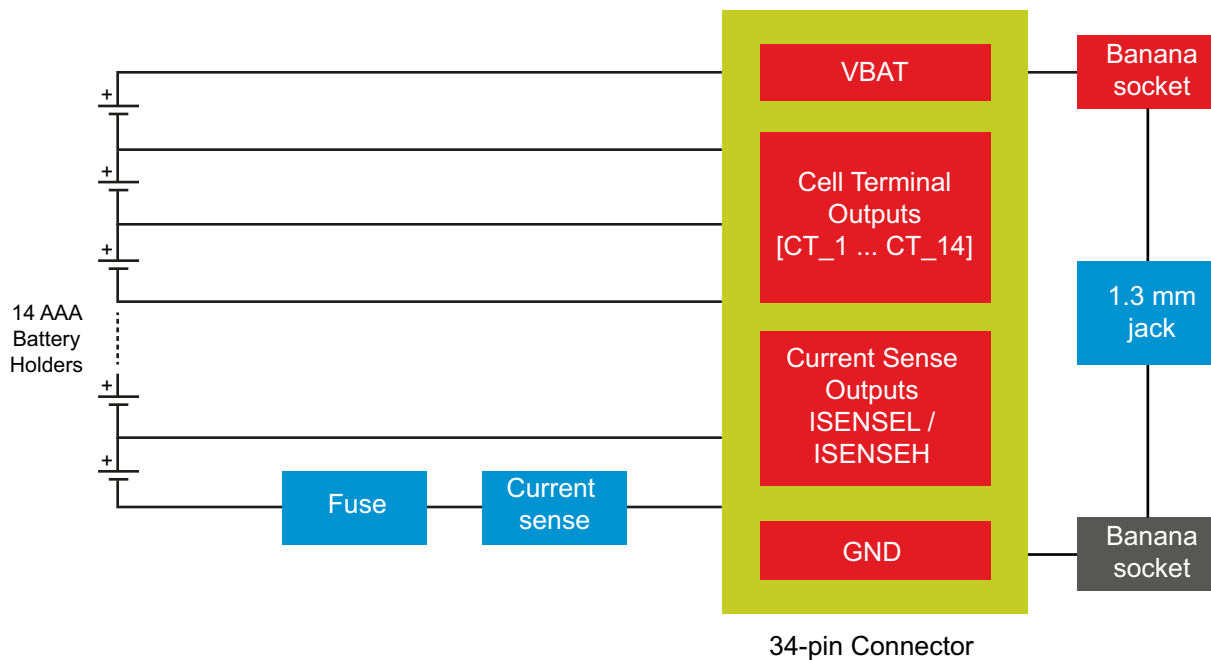

Figure 2. BATT-14AAAPACK Block Diagram

4 Getting to Know the Hardware

Figure 3 and Figure 4 illustrate components of the BATT-14AAAPACK.

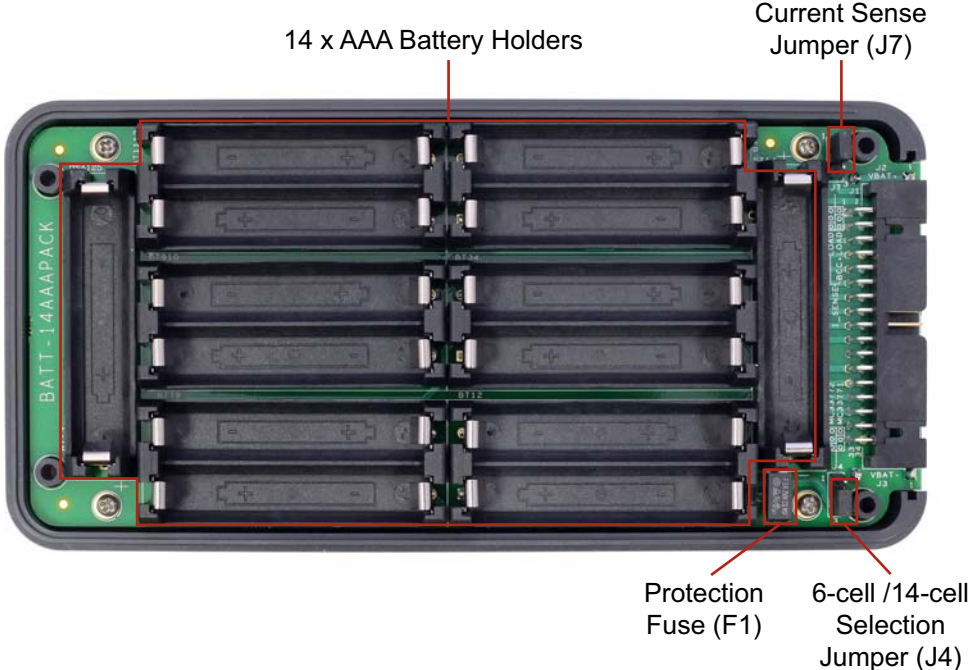

Figure 3. Top View

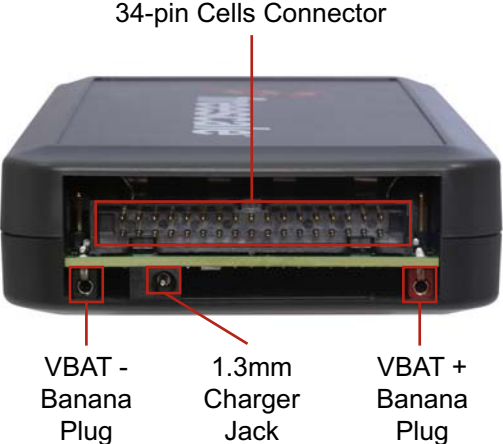

Figure 4. Side View

4.1 AAA Battery Holders

The battery pack includes 14 AAA battery holders connected in series. Each battery holder connects to the 34-pin connector and emulates the voltage cells that connect to the MC3377x cell terminals in a real application.

The battery pack accepts any battery lower than 4.4 V that is compatible with the AAA format. For example:

- AAA 1.2 V NiMh batteries
- AAA 1.5 V Alkaline batteries
- 10440 3.7 V Lithium-ion batteries (flat top is preferred)

The bottom silkscreen of the PCB indicates the cell number for each battery holder.

A configuration jumper J4 allows you to route CT6 either to the next battery holder (MC33771 configuration), or to VBAT (MC33772 configuration). Place a jumper connection on J4 for the pack to be functional.

4.2 34-pin Cells Connector

The fourteen cells connect to the EVB through 34-pin header [X1-1...X1-34]:

Table 1. 34-pin Connector Pinout

Pin Number	Connection	Description
X1-1 X1-2	VBAT	MC3377x Power supply
X1-3 X1-4	CT_14	Cell pin 14 output
X1-5 X1-6	CT_13	Cell pin 13 output
X1-7 X1-8	CT_12	Cell pin 12 output
X1-9 X1-10	CT_11	Cell pin 11 output
X1-11 X1-12	CT_10	Cell pin 10 output
X1-13 X1-14	CT_9	Cell pin 9 output
X1-15 X1-16	CT_8	Cell pin 8 output
X1-17 X1-18	CT_7	Cell pin 7 output
X1-19 X1-20	CT_6	Cell pin 6 output
X1-21 X1-22	CT_5	Cell pin 5 output
X1-23 X1-24	CT_4	Cell pin 4 output
X1-25 X1-26	CT_3	Cell pin 3 output
X1-27 X1-28	CT_2	Cell pin 2 output
X1-29 X1-30	CT_1	Cell pin 1 output
X1-31	ISENSE_+	Current measurement output
X1-32	ISENSE_--	Current measurement output
X1-33	CT_REF	Cell pin REF output
X1-34	GND	Negative_Battery

4.3 Current Sense Resistor

A 0.1 Ω current sense resistor (R1) on the main board senses current based on the voltage differential between the MC3377x's ISENSE+ and ISENSE- pins.

A configuration jumper (J7) allows you to select between two options:

- J7-1 and J7-2: senses the current of the LOAD connected between the black and red banana sockets.
- J7-2 and J7-3: senses the current of the MC3377x + the LOAD connected between the black and red banana sockets. This allows you to measure the MC3377x alone if no load is present.

If a current sense is already present on the EVB, disconnect the battery pack sense resistor, either by unsoldering R1, or unsoldering R2 and R3.

4.4 Protection Fuse

An on-board 2.0 A fast-acting fuse protects the battery stack from overcurrent damage. To find replacement fuses on distributor websites, search for TE5 250V radial fuses.

4.5 2mm Banana Connectors

MC33771 and MC33772 devices are designed to monitor a full system including a battery pack and its load. Optionally, you can connect the load to the battery pack using the red (VBAT) and black (GND) 2mm banana connectors.

4.6 1.3mm Serial Charging Jack

The BATT-14AAAPACK includes 1.3mm jack on the front of the pack to support external charging of the battery stack. However, the battery pack contains no internal charging circuitry. The pack also contains no overcurrent protection other than the F1 fuse. Therefore, be sure to select the proper smart charger when serial charging the batteries.

The following websites provide examples of proper serial chargers:

- NiMH Chemistry
www.mascot.no/admin/common/getimg.asp?FileID=1203
www.mascot.no/admin/common/getimg.asp?FileID=1212
- Li-Ion Chemistry
fypoweradapter.manufacturer.globalsources.com/si/6008825690079/pdtl/Standard-battery/1119867844/58V-Battery-Charger.htm

Caution:

Do not attempt to charge the battery pack with a charger that is not adapted to the batteries' chemistry or to the battery cell voltage.

5 Configuring the Hardware

5.1 Basic Configurations

The BATT-14AAAPACK is configured by default for an MC33771 and LOAD current sense.

To use the battery pack with the MC33772, position the jumper J4 between pins 1 and 2. This routes CT6 directly to VBAT.

To measure the MC3377x + LOAD current through the 0.1 ohm sense resistor, position the jumper J7 between pins 2 and 3.

Note:

For the pack to be function, jumpers must be positioned on J4 and J7, and the fuse F1 must be in place. Otherwise the battery stack is an open circuit.

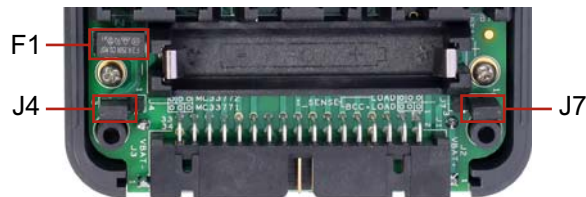

Figure 5. BATT-14AAAPACK Configurations



Figure 6. BATT-14AAAPACK Connection to KIT33771TPLEVB

5.2 Cell Configuration

The battery pack allows you to configure from three to six cells when used with the MC33772 and from seven to fourteen cells when used with the MC33771. The exact number of required cells depends on the device version. You may need to place AAA dummy batteries in some of the battery holders to match the requirements of your device. AAA dummy batteries are available from a number of online suppliers.

For each configuration, the following table indicates the cells that should contain a dummy battery or a real battery. [Figure 7](#) shows the location number of each cell (also shown on the bottom of the PCB.)

Table 2. Cell Connections for all Configurations

Number of cells	3	4	5	6	7	8	9	10	11	12	13	14	
Device	MC33772				MC33771								
Jumper J4	Pins 1—2				Pins 2—3								
Cell1	Batt	Batt	Batt	Batt	Batt	Batt	Batt	Batt	Batt	Batt	Batt	Batt	
Cell2	Batt	Batt	Batt	Batt	Batt	Batt	Batt	Batt	Batt	Batt	Batt	Batt	
Cell3	Short	Short	Short	Batt	Batt	Batt	Batt	Batt	Batt	Batt	Batt	Batt	
Cell4	Short	Short	Batt	Batt	Batt	Batt	Batt	Batt	Batt	Batt	Batt	Batt	
Cell5	Short	Batt	Batt	Batt	Short	Short	Short	Short	Short	Short	Short	Batt	
Cell6	Batt	Batt	Batt	Batt	Short	Short	Short	Short	Short	Short	Batt	Batt	
Cell7	Not Configurable				Short	Short	Short	Short	Short	Batt	Batt	Batt	
Cell8					Short	Short	Short	Short	Batt	Batt	Batt	Batt	
Cell9					Short	Short	Short	Batt	Batt	Batt	Batt	Batt	
Cell10					Short	Short	Batt	Batt	Batt	Batt	Batt	Batt	
Cell11					Short	Batt	Batt	Batt	Batt	Batt	Batt	Batt	
Cell12					Batt	Batt	Batt	Batt	Batt	Batt	Batt	Batt	
Cell13					Batt	Batt	Batt	Batt	Batt	Batt	Batt	Batt	
Cell14					Batt	Batt	Batt	Batt	Batt	Batt	Batt	Batt	

Short Insert a 0 V battery or short the battery holder **Batt** Insert a real battery

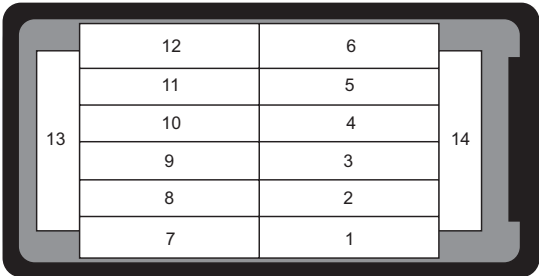

Figure 7. Cell Location Numbers



Figure 8. Twelve-cell Configuration Example

6 Schematic

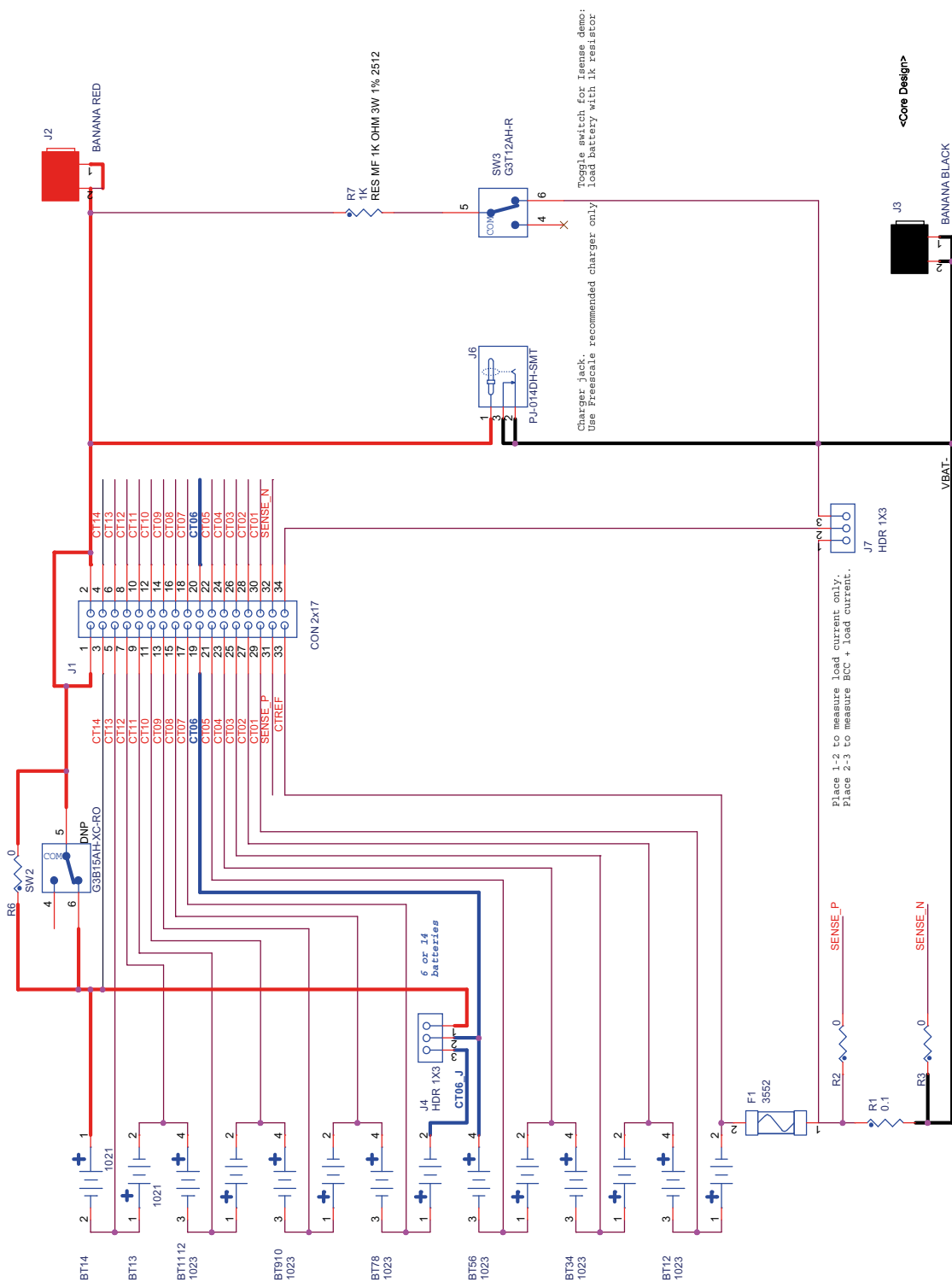

Figure 9. Battery Pack Board Schematic

7 Board Layout

7.1 Top Assembly Layer and Top Routing

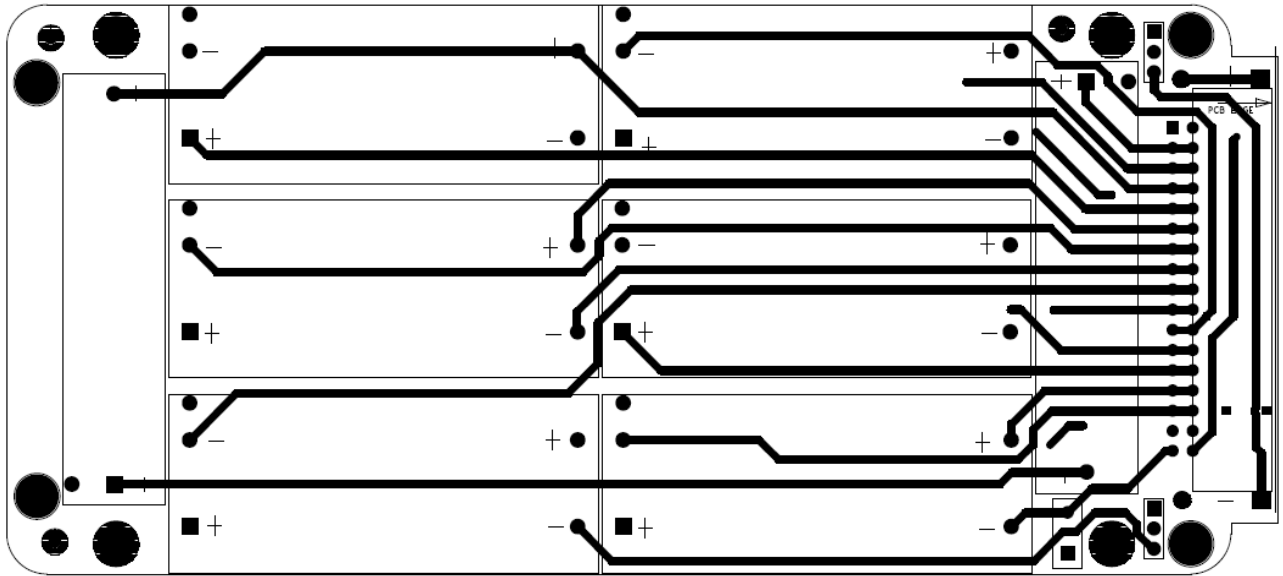

Figure 10. Top Layer Assembly Layer and Top Routing

7.2 Bottom Layer Assembly and Bottom Routing

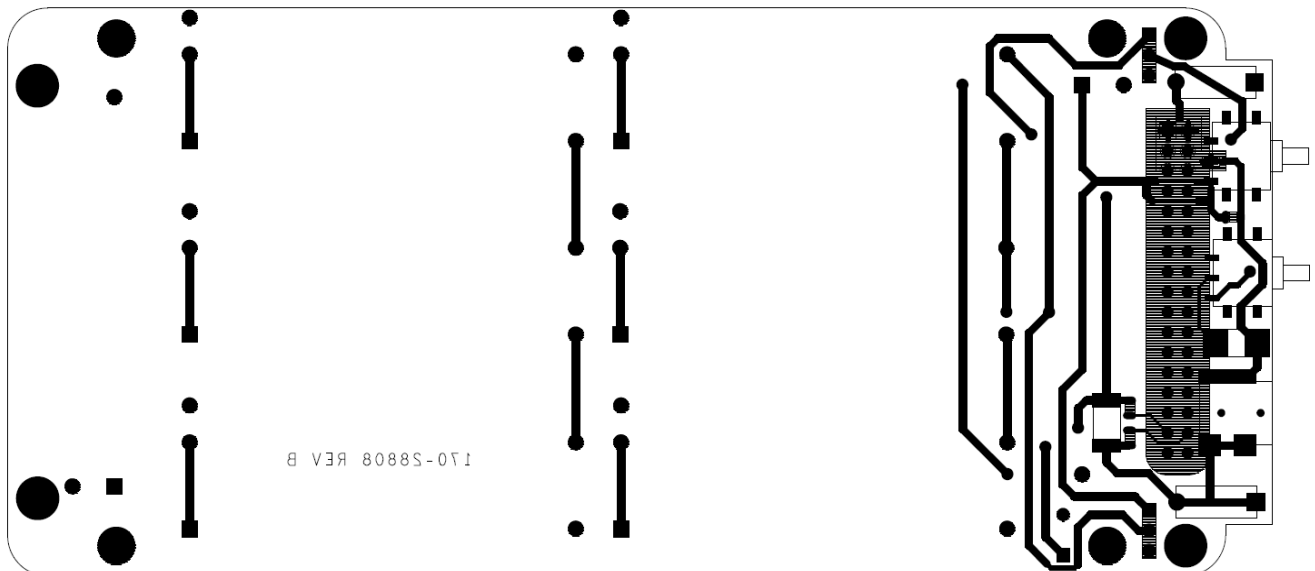

Figure 11. Bottom Layer Assembly and Bottom Routing

8 Board Bill of Materials

 Table 3. Bill of Materials⁽¹⁾

Item	Qty	Schematic Label	Value	Description	Part Number	Assy Opt
Resistors						
1	1	R1	0.1 Ω	RES MF 0.1 OHM 1 W 1% 2512	WSLT2512R1000FEA	
2	3	R2, R3, R6	0 Ω	RES MF ZERO OHM 1/8 W -- 0805	RC0805JR-070RL	
3	1	R7	1 K Ω	RES MF 1K OHM 3 W 1% 2512	35221K0FT	
Switches, Connectors, Jumpers and Test Points						
4	6	BT12, BT34, BT56, BT78, BT910, BT1112		BATT HOLDER 2CELL AAA TH	1023	
5	2	BT13, BT14		BATT HOLDER 1CELL AAA TH	1021	
6	1	F1		FUSE HOLDER SUBMINIATURE TH	3552	
7	1	J1		CON 2X17 PLUG SHRD RA TH 100MIL CTR 343H AU 112L	D2534-5002-AR	
8	1	J2		CON 1 BANANA DIN41649 RED SKT RA TH -- 228H SN 217L	930224101	
9	1	J3		CON 1 BANANA DIN41649 BLACK SKT RA TH -- 228H SN 217L	930224100	
10	2	J4,J7		HDR 1X3 TH 2.54MM SP 344H AU 118L	61300311121	
11	1	J6		CON 3 PWR RA SMT -- NI 1.3MM CTR PIN	PJ-014DH-SMT	
12	1	SW2		SW SPDT MOM PB RA 28 V 0.1 A SMT	G3B15AH-XC-RO	(2)
13	1	SW3		SW SPDT TOGGLE RA 0.4VA 28 V SMT	G3T12AH-R	(2)

Notes

1. Freescale does not assume liability, endorse, or warrant components from external manufacturers are referenced in circuit drawings or tables. While Freescale offers component recommendations in this configuration, it is the customer's responsibility to validate their application.
2. Do not populate

9 References

Following are URLs where you can obtain information on related Freescale products and application solutions:

Freescale.com Support Pages	Description	URL
BATT-14AAAPACK	Tool Summary Page	www.freescale.com/BATT-14AAAPACK
MC33771	Product Summary Page	www.freescale.com/webapp/sps/site/prod_summary.jsp?code=MC33771
MC33772	Product Summary Page	www.freescale.com/webapp/sps/site/prod_summary.jsp?code=MC33772
KIT33771ASP1EVB	Tool Summary Page	www.freescale.com/products/analog-power-management/battery-management/battery-cell-controllers/evaluation-board-mc33771-14-channel-li-ion-battery-cell-controller-ic:KIT33771ASP1EVB

9.1 Support

Visit www.freescale.com/support for a list of phone numbers within your region.

9.2 Warranty

Visit www.freescale.com/warranty to submit a request for tool warranty.

10 Revision History

Revision	Date	Description of Changes
1.0	10/2015	<ul style="list-style-type: none"> • Initial Release

How to Reach Us:

Home Page:
freescale.com

Web Support:
freescale.com/support

Information in this document is provided solely to enable system and software implementers to use Freescale products. There are no express or implied copyright licenses granted hereunder to design or fabricate any integrated circuits based on the information in this document.

Freescale reserves the right to make changes without further notice to any products herein. Freescale makes no warranty, representation, or guarantee regarding the suitability of its products for any particular purpose, nor does Freescale assume any liability arising out of the application or use of any product or circuit, and specifically disclaims any and all liability, including without limitation consequential or incidental damages. "Typical" parameters that may be provided in Freescale data sheets and/or specifications can and do vary in different applications, and actual performance may vary over time. All operating parameters, including "typicals," must be validated for each customer application by customer's technical experts. Freescale does not convey any license under its patent rights nor the rights of others. Freescale sells products pursuant to standard terms and conditions of sale, which can be found at the following address: freescale.com/SalesTermsandConditions.

Freescale and the Freescale logo are trademarks of Freescale Semiconductor, Inc., Reg. U.S. Pat. & Tm. Off. SMARTMOS is a trademarks of Freescale Semiconductor, Inc. All other product or service names are the property of their respective owners.

© 2015 Freescale Semiconductor, Inc.