

ISL1904DEMO1Z: Offline Triac Dimmable Isolated LED Driver

Introduction

The ISL1904DEMO1Z demo board converts a high line AC input voltage to a 18V, 700mA DC output. It is implemented with Intersil's critical conduction mode (CrCM) LED driver controller, the ISL1904. It demonstrates the fundamental functions of ISL1904, including soft-start, dimming, over-voltage protection, short circuit protection, etc. The circuit operates in CrCM with variable frequency and allows near zero-voltage switching (ZVS). Typical efficiency is about 81% at full load. The ISL1904DEMO1Z demo board supports phase dimming and is compatible with wide variety of leading and trailing edge dimmers available in the market. This application note covers the performance data, critical waveforms, extensive dimming data, schematics, layout and bill of materials.

Design Specifications

- Input voltage V_{IN} : 176V to 264V
- Output voltage V_O : 12V to 20V
- Output current I_O : 700mA (14W)
- Board dimensions: $68 \times 26 \times 15 \text{mm}^3$ (L×W×H)
- Input power factor greater than 0.93 at nominal
- Total harmonic distortion less than 7% at nominal
- Peak efficiency at full load: 81%
- 0-100% flicker free dimming with leading and trailing edge dimmers

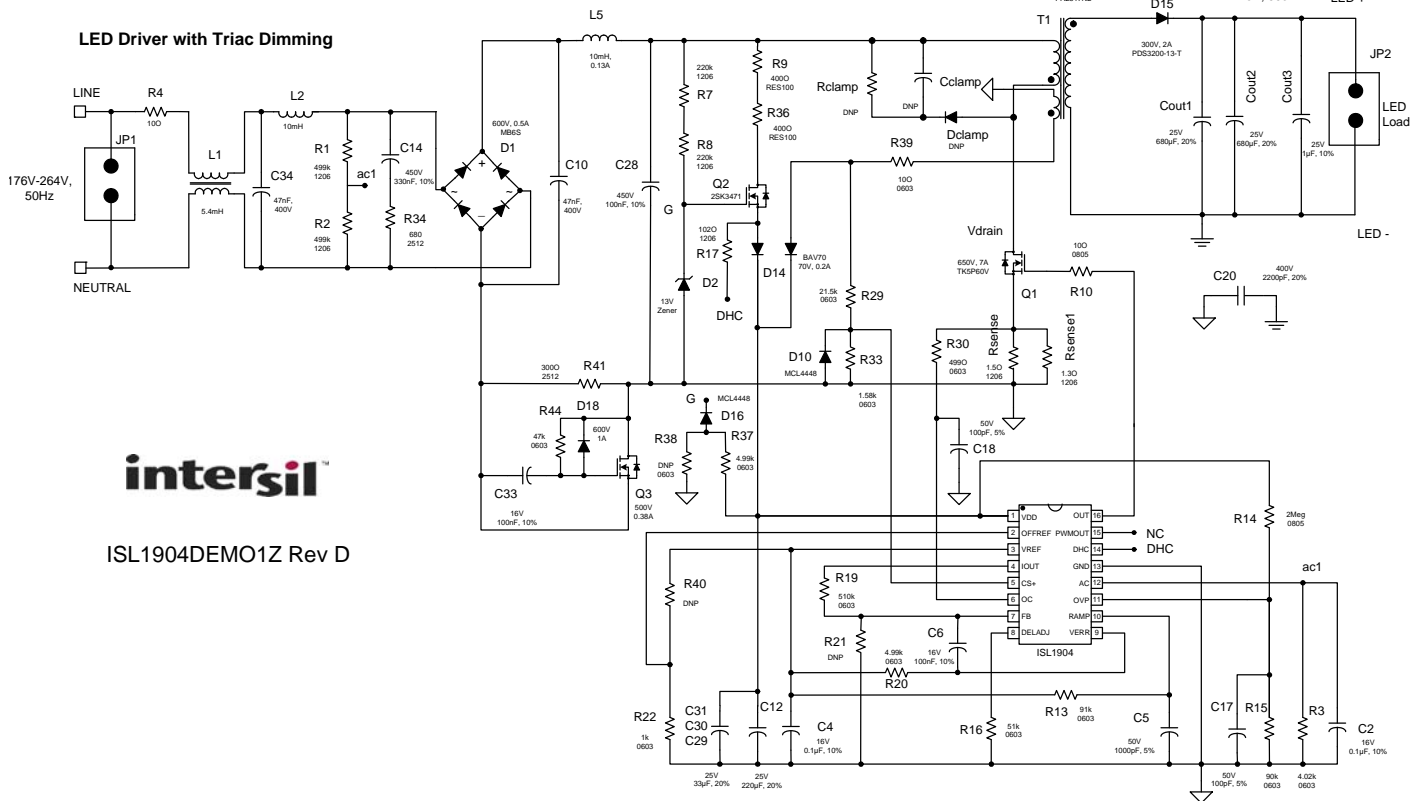

FIGURE 1. ISOLATED FLYBACK CONVERTER APPLICATION SCHEMATIC

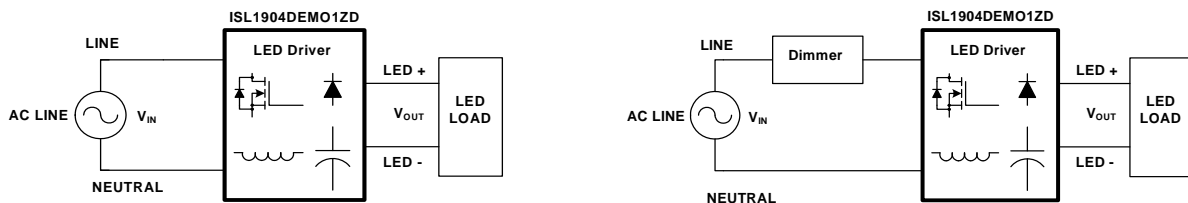

FIGURE 2. TEST SETUP WITH AND WITHOUT DIMMING

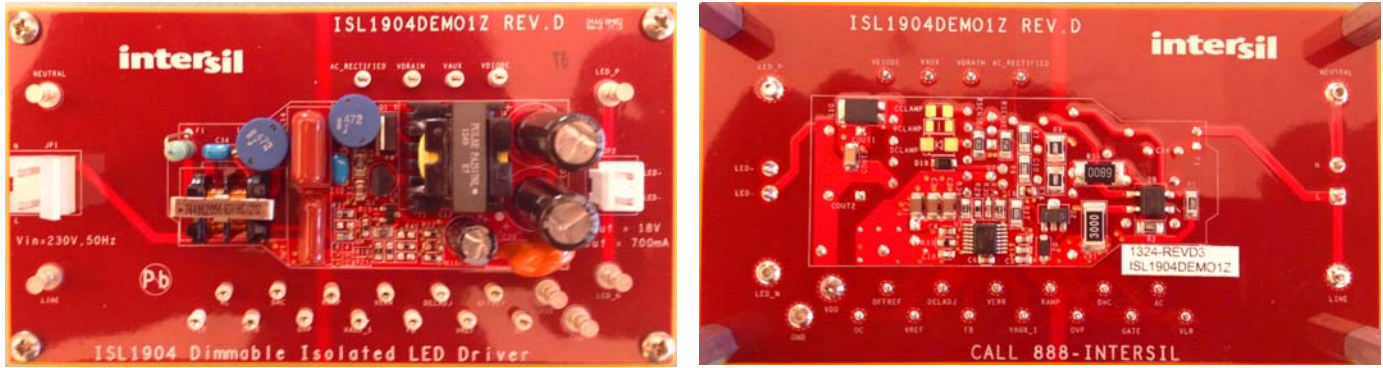

FIGURE 3. TOP/BOTTOM VIEW OF THE EVALUATION BOARD

Schematic Description

General Description of ISL1904

The ISL1904 is a high-performance, critical conduction mode (CrCM), single-ended flyback LED driver controller. It supports single-stage conversion of the AC mains to a constant current source with power factor correction (PFC). It also may be used with DC input converters. The ISL1904 also supports boost, Cuk, sepic and buck-boost converters. Operation in CrCM allows near zero-voltage switching (ZVS) for improved efficiency while maximizing magnetic core utilization. The ISL1904 LED driver provides all of the features required for high-performance dimmable LED driver designs.

Input EMI Filtering

Fusible resistor R4 provides protection from components failure. Input EMI filtering is provided by differential inductors L2, L5 and capacitors C14 and C28. The switching current generated by the power-train to the AC line is filtered by the input filter network.

Start-up Network

A linear regulator startup network is used for initial startup. R7, R8, R9, R36, Q2 and D2 constitute the linear startup circuit. Once the energy is built and voltage is generated on the aux winding, the linear regulator circuit is disabled and the aux winding supplies the voltage and current to the controller IC.

Power Stage

The primary current loop encompasses the transformer primary winding, MOSFET Q1 and the current sense resistors Rsense and Rsense1.

Near zero voltage switching (ZVS) or quasi-resonant switching, as it is sometimes referred to, can be achieved by delaying the next switching cycle after the inductor current decays to zero. The delay allows the inductance and parasitic capacitance to oscillate, causing the switching FET drain-source voltage to ring down to minima. If the FET is turned on at this minima, the capacitive switching losses ($\frac{1}{2}CV^2$) are greatly reduced.

Inductor zero-crossing is detected using the transformer aux winding. R29, R12 scales down the sensed zero crossing voltage and is delivered to the IC. Deladj sets the delay before a new switching cycles starts. This adjustment allows the user to delay the next switching cycle until the switching FET drain-source

voltage reaches a minimum value to allow quasi-ZVS (Zero Voltage Switching) operation. Resistor R16 to ground programs the delay.

DELAY TIME SETTING

In order to reduce electromagnetic interference and switching loss, ISL1904 can insert a delay between the off period and the on period. A resistor connected from deladj pin to ground will program the delay time according to the equation below. The optimal delay time depends on the resonance between the inductance, drain-source capacitance (Coss) and parasitic capacitance on the drain node. Circuit designers should optimize the delay according to the following equation:

$$f_{sw} = \frac{1}{2\pi \sqrt{L_p(C_{oss} + C_{stray})}}$$

After determining the delay time, the resistor can be chosen according to the following equation:

$$R_{del} = \left| \frac{(T_{del} - 73.33)}{10.2} \right| k\Omega$$

Resistor R16 programs this delay in the application schematic.

Feedback

The ISL1904 is designed to regulate the LED current by monitoring the primary switch current at the OC pin through resistors Rsense and Rsense1. The peak primary switch current is captured, processed, and output on IOU_T as a PWM voltage signal modulated in proportion to the LED current. The IOU_T PWM frequency is the same as the converter switching frequency and its amplitude is equivalent to 4x the peak switch current during the previous ON-time. Resistor R19 scales the signal before being input to the control loop at the FB pin. The OC pin also provides cycle-by-cycle overcurrent protection. The ON-time is terminated if OC exceeds 0.6V nominal. There is ~120ns of leading edge blanking (LEB) on OC to minimize or eliminate external filtering.

Output Rectification

Transformer secondary winding voltage is rectified by diode D15 and filtered by capacitors Cout1, Cout2 and Cout3. The capacitors are connected in parallel as the combination has a lower parasitic inductance and resistance compared to a single capacitor.

Application Note 1845

Overvoltage Protection

ISL1904 has an independent overvoltage protection accessed through the OVP pin. There is a nominal 20µA switched current source to create hysteresis. The current source is active only during an OV fault; otherwise, it is inactive and does not affect the node voltage.

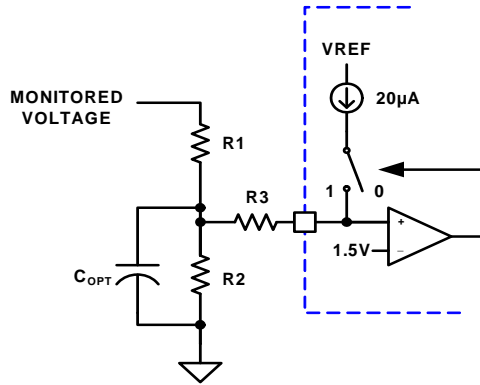

FIGURE 4. OV HYSTERESIS

$$V = 1.5 \frac{(R1 + R2)}{R2} V$$

Hysteresis is given by: $\Delta V = 20 \times 10^{-6} \times R1 V$

DESIGN EXAMPLE

Flyback converter Inductance calculation

TABLE 1.

PARAMETER	VALUE	DESCRIPTION
$V_{min(rms)}$	176V	Min rms input voltage
$V_{max(rms)}$	264V	Max rms input voltage
η		Efficiency
$f_{min(avg)}$	100kHz	Frequency when $V_{IN} = \min V_{IN(rms)}$
D_{max}	0.4	Maximum duty cycle
V_{OUT}	18V	Output voltage
I_{OUT}	0.7	LED current
I_{spk}		Peak secondary current - avg
I_{ppk}		Peak primary current - avg
I_{spkmax}		Peak secondary current - max
I_{ppkmax}		Peak primary current - max
C_{oss}		MOSFET drain-source capacitance
C_{other}		Parasitic capacitance on drain node

Secondary inductance is calculated as:

$$L_s = \frac{V_o(1 - D_{max})^2}{2 \times f \times I_{out}} = \frac{18(1 - 0.4)^2}{2 \times 100 \times 10^3 \times 0.7} = 46.3 \mu H$$

Primary to sec turns ratio:

$$N_{sp} = \frac{V_o(1 - D_{max})}{V_{minpk} \times D_{max}} = \frac{18(1 - 0.4)}{176 \times \sqrt{2} \times 0.4} = 0.11$$

Primary Inductance:

$$L_p = \frac{L_s}{N_{sp}^2} = \frac{46.3 \mu H}{0.11^2} = 2.89 mH$$

Bias voltage: $V_{bias} = 12V$

Aux voltage is: $V_{aux} = V_{bias} + 0.7 = 12.7V$

Aux winding inductance is:

$$L_{aux} = L_s \frac{V_{aux}^2}{(N_{sp} \times V_f + V_d)^2} = 16.9 \mu H$$

Peak secondary current (avg) is:

$$I_{spk} = \frac{V_{out}(1 - D_{max})}{f \times L_s} = \frac{18(1 - 0.4)}{100 \times 10^3 \times 46.3 \times 10^{-6}} = 2.75 A$$

Peak primary current (avg) is:

$$I_{ppk} = I_{spk} \times N_{sp} = 2.75 \times 0.11 = 0.344 A$$

Maximum peak primary current is:

$$I_{ppkmax} = \frac{V_{minpk} \times T_{on} \times \sqrt{2}}{L_p} = 0.49 A$$

Maximum peak secondary current is

$$I_{spkmax} = \frac{I_{ppkmax}}{N_{sp}} = 3.88 A$$

Time period is: $T_s = \frac{1}{f_s} = 10 \mu s$

Maximum ON time is $T_{onmax} = D_{max} \times T_s = 4 \mu s$

Delay time to program partial zero voltage switching:

$$T_{delay} = \frac{\pi \sqrt{L_p(C_{oss} + C_{other})}}{2} = 1005 ns$$

Worst case minimum frequency is

$$f_{min} = \frac{1}{T_{on} + T_{offmax} + T_{delay}} = 80.09 kHz$$

OFFREF control:

$$REFIN(off) = OFFREF - 0.1$$

$$REFIN(on) = OFFREF - 0.05$$

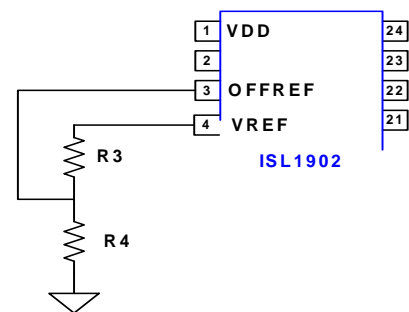

FIGURE 5.

$$OFFREF = \frac{R4}{R3 + R4} V_{ref}$$

Performance Data

TABLE 2. PERFORMANCE DATA WITH VARIATION IN TEMPERATURE

TEMP (°C)	V _{IN} (V)	V _{OUT} (V)	I _{OUT} (mA)	P _{OUT} (W)	P _{IN} (W)	EFF (%)	PF (%)	THD (%)
-35	220	18.57	709.21	16.86	13.17	78.13	90.97	7.704
-20	220	18.57	703.74	16.71	13.07	78.24	90.88	7.69
5	220	18.42	714.72	16.40	13.16	80.25	90.68	8.22
25	220	18.47	704.50	16.31	13.01	79.80	90.68	8.19
50	220	18.61	705.02	16.27	13.12	80.66	90.89	7.87
75	220	18.51	709.35	16.07	13.13	81.72	90.89	7.86
105	220	18.46	692.26	15.81	12.78	80.82	90.75	7.56
125	220	18.40	664.58	15.46	12.23	79.09	90.22	7.61

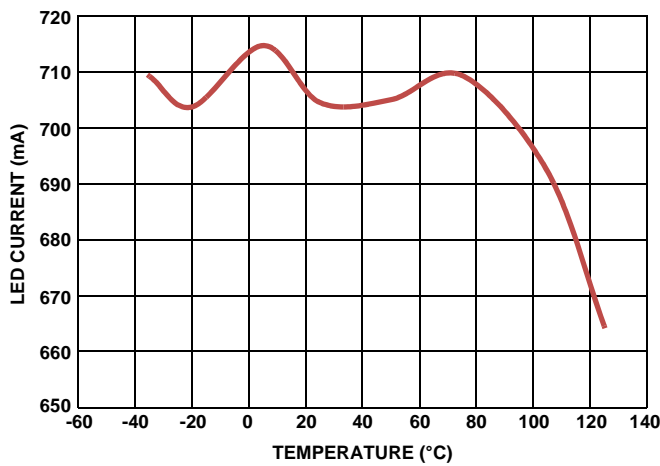

FIGURE 6. VARIATION OF LED CURRENT WITH AMBIENT TEMPERATURE

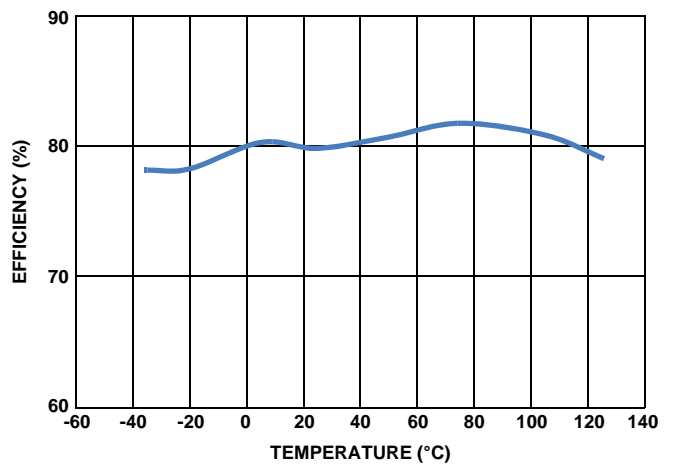

FIGURE 7. VARIATION OF EFFICIENCY WITH AMBIENT TEMPERATURE

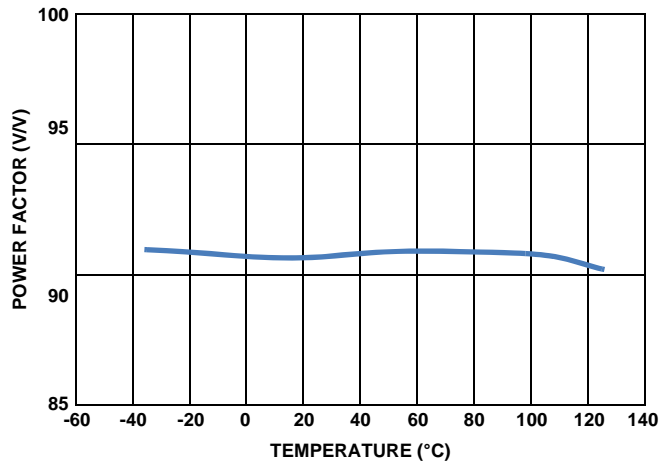

FIGURE 8. VARIATION OF POWER FACTOR WITH AMBIENT TEMPERATURE

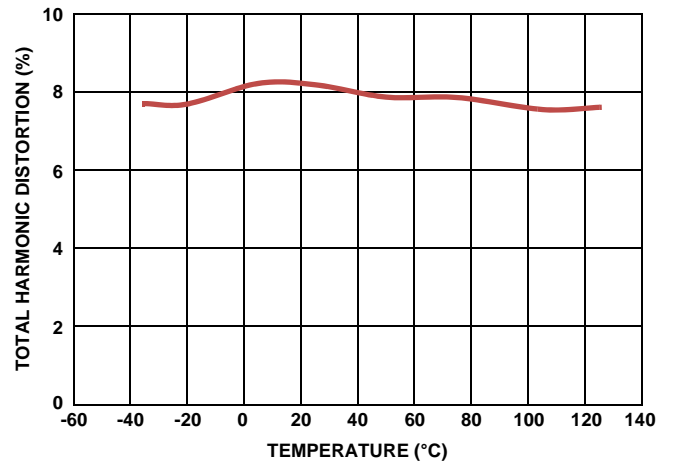

FIGURE 9. VARIATION OF THD WITH AMBIENT TEMPERATURE

Application Note 1845

TABLE 3. PERFORMANCE DATA WITH 5 LED LOAD

V _{RMS} (V)	V _{PK} (V)	I _N (mA)	V _{OUT} (V)	I _{OUT} (mA)	P _{IN} (W)	P _{OUT} (W)	P _{LOSS} (W)	EFFI (%)	PF (%)	ATHD (%)
AVERAGE		69.10	15.37	683.93	13.43	10.52	2.92	78.27	89.94	9.70
170.10	240.60	81.25	15.36	685.02	13.39	10.52	2.87	78.56	96.92	8.02
180.08	254.70	77.66	15.37	703.22	13.39	10.81	2.58	80.74	95.75	8.44
190.10	268.80	74.69	15.39	686.58	13.41	10.57	2.84	78.80	94.45	8.90
200.08	283.00	72.09	15.41	687.77	13.45	10.60	2.85	78.79	93.23	9.15
210.10	297.10	69.85	15.40	700.54	13.50	10.79	2.71	79.92	91.99	9.45
220.11	311.30	67.86	15.40	696.67	13.52	10.73	2.79	79.35	90.52	9.76
230.11	325.40	66.06	15.38	695.25	13.51	10.69	2.82	79.13	88.87	10.25
240.03	339.50	64.45	15.36	679.63	13.47	10.44	3.04	77.47	87.09	10.36
250.10	353.70	63.05	15.37	669.18	13.44	10.28	3.16	76.52	85.22	10.62
260.14	367.90	61.81	15.34	658.98	13.37	10.11	3.26	75.62	83.13	10.89
264.19	373.60	61.36	15.35	660.37	13.33	10.14	3.19	76.07	82.20	10.83

TABLE 4. PERFORMANCE DATA WITH 6 LED LOAD

V _{RMS} (V)	V _{PK} (V)	I _N (mA)	V _{OUT} (V)	I _{OUT} (mA)	P _{IN} (W)	P _{OUT} (W)	P _{LOSS} (W)	EFFI (%)	PF (%)	ATHD (%)
AVERAGE		78.391	18.35	684.48	15.70	12.56	3.14	80.01	92.52	8.37
170.12	240.60	92.10	18.32	669.43	15.32	12.27	3.05	80.08	97.77	7.04
180.08	254.70	87.81	18.35	673.88	15.30	12.36	2.94	80.80	96.77	7.39
190.11	268.90	84.24	18.32	679.84	15.32	12.46	2.87	81.30	95.68	7.75
200.09	283.00	81.25	18.36	679.71	15.40	12.48	2.92	81.02	94.72	8.12
210.10	297.10	78.75	18.33	676.66	15.52	12.40	3.12	79.91	93.81	8.34
220.12	311.30	76.66	18.36	683.45	15.65	12.55	3.11	80.16	92.76	8.67
230.11	325.40	74.91	18.35	693.90	15.79	12.73	3.06	80.63	91.61	8.82
240.04	339.50	73.40	18.36	698.04	15.93	12.82	3.11	80.46	90.42	8.94
250.11	353.70	72.05	18.34	690.84	16.07	12.67	3.40	78.83	89.19	8.98
260.15	367.90	70.80	18.37	694.93	16.17	12.76	3.41	78.93	87.80	8.99
264.20	373.60	70.33	18.35	688.61	16.19	12.63	3.56	78.01	87.15	9.05

TABLE 5. PERFORMANCE DATA WITH 7 LED LOAD

V _{RMS} (V)	V _{PK} (V)	I _N (mA)	V _{OUT} (V)	I _{OUT} (mA)	P _{IN} (W)	P _{OUT} (W)	P _{LOSS} (W)	EFFI (%)	PF (%)	ATHD (%)
AVERAGE		86.76	21.36	662.70	17.64	14.16	3.48	80.28	93.98	7.35
170.11	240.60	103.45	21.38	652.23	17.32	13.95	3.37	80.549	98.39	6.35
180.08	254.70	98.39	21.38	649.51	17.28	13.89	3.39	80.37	97.53	6.69
190.10	268.80	93.96	21.37	650.78	17.24	13.91	3.34	80.66	96.57	7.00
200.07	282.90	90.17	21.39	651.76	17.27	13.94	3.33	80.70	95.76	7.23
210.11	297.10	87.05	21.38	659.59	17.38	14.10	3.27	81.16	95.02	7.50
220.14	311.30	84.45	21.36	665.39	17.50	14.21	3.29	81.20	94.13	7.74
230.11	325.40	82.28	21.39	671.36	17.64	14.35	3.29	81.37	93.16	7.63
240.03	339.50	80.49	21.34	671.95	17.81	14.34	3.47	80.52	92.17	7.71
250.11	353.70	79.03	21.34	667.17	18.03	14.24	3.79	78.98	91.21	7.68
260.14	367.90	77.81	21.33	673.70	18.25	14.37	3.88	78.76	90.15	7.67
264.19	373.60	77.37	21.35	676.25	18.33	14.44	3.89	78.78	89.66	7.67

Application Note 1845

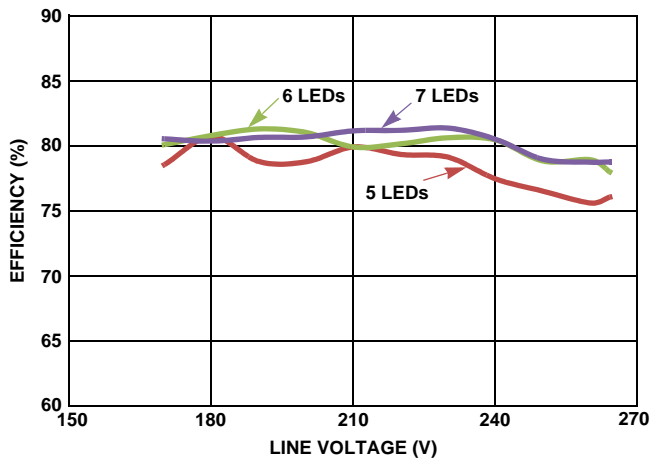

FIGURE 10. EFFICIENCY WITH LINE VOLTAGE AT DIFFERENT LOADS

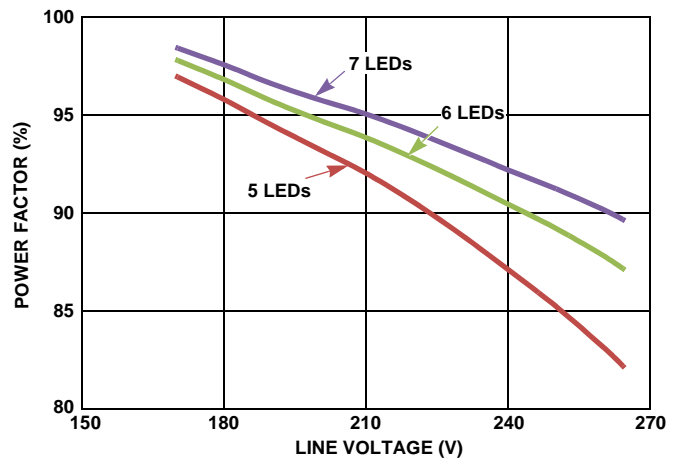

FIGURE 11. POWER FACTOR WITH LINE VOLTAGE AT DIFFERENT LOADS

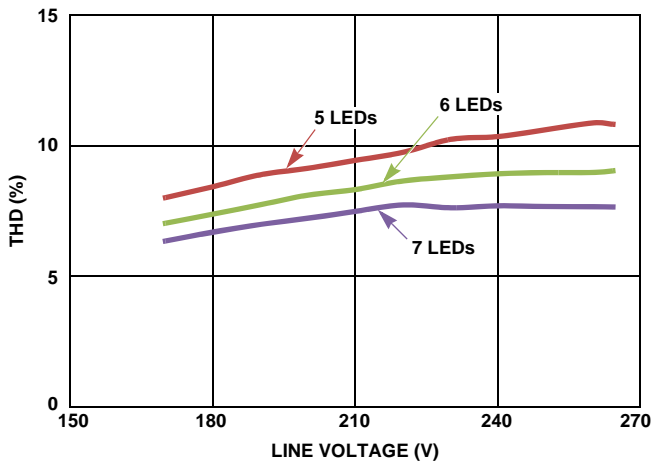

FIGURE 12. THD WITH LINE VOLTAGE AT DIFFERENT LOADS

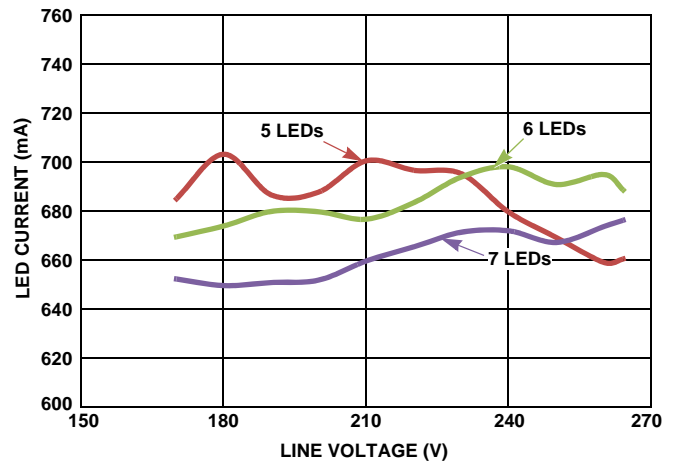

FIGURE 13. LED CURRENT WITH LINE VOLTAGE AT DIFFERENT LOADS

Critical Waveforms

WAVEFORM SHOWING LINE VOLTAGE AND LINE CURRENT: PF = 0.92

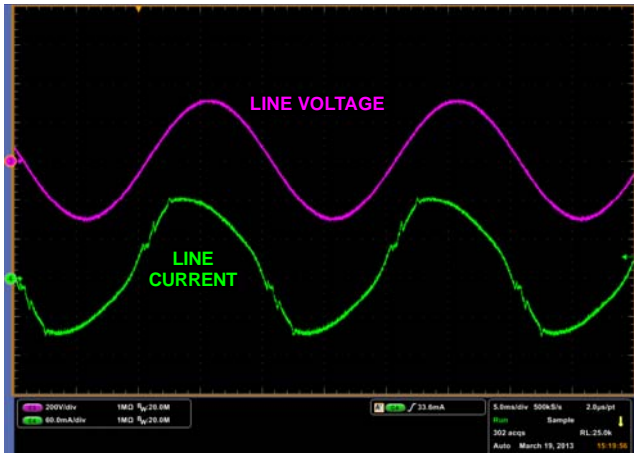

FIGURE 14. TRACE 3 - INPUT VOLTAGE [200V/DIV]; TRACE 4 - INPUT CURRENT [60mA/DIV]

LINE VOLTAGE AND CURRENT DURING STARTUP

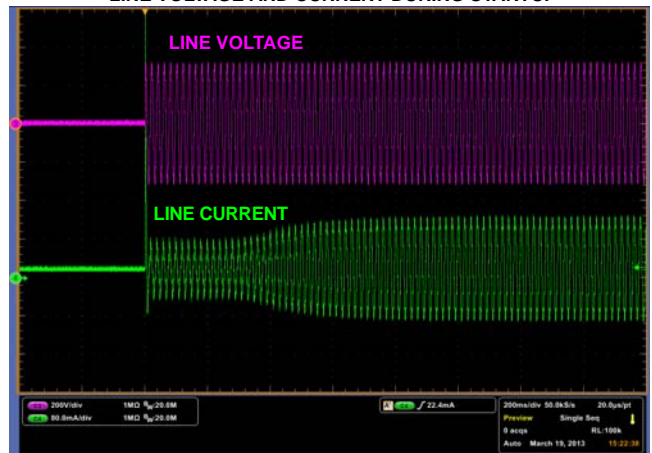

FIGURE 15. INPUTS DURING STARTUP; TRACE 3 - INPUT VOLTAGE [200V/DIV]; TRACE 4 - INPUT CURRENT [60mA/DIV]

Critical Waveforms (Continued)

WAVEFORM DEPICTING SOFT-START

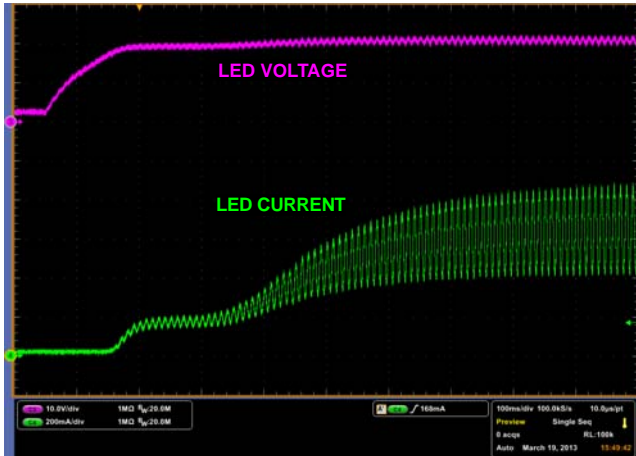

FIGURE 16. TRACE 3 - OUTPUT VOLTAGE [10V/DIV]; TRACE 4 - LED CURRENT [200mA/DIV]

WAVEFORM SHOWING LED RIPPLE CURRENT - 35% PK-AVG RIPPLE

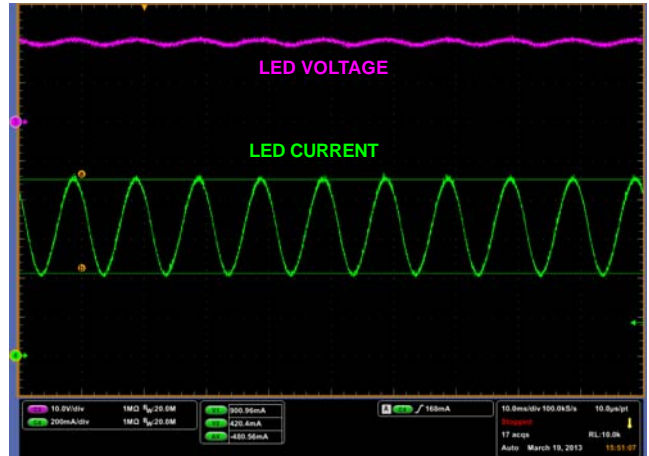

FIGURE 17. TRACE 3 - OUTPUT VOLTAGE [10V/DIV]; TRACE 4 - LED CURRENT [200mA/DIV]; LED CURRENT RIPPLE: 35% PK-AVG OR 1.35 CREST FACTOR

SWITCHING WAVEFORMS

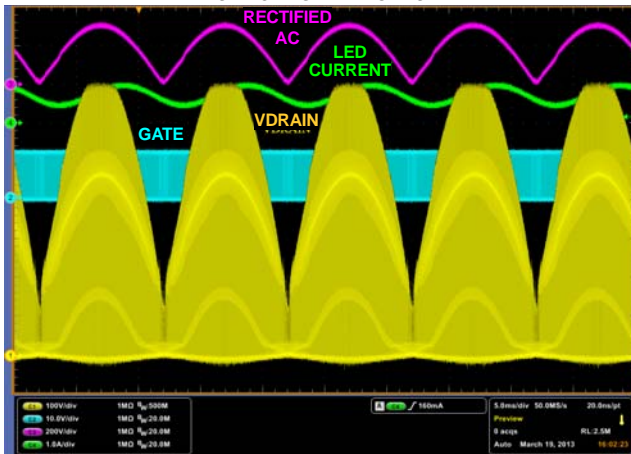

FIGURE 18. TRACE 1 - DRAIN VOLTAGE [100V/DIV]; TRACE 2 - GATE [10V/DIV]; TRACE 3 - RECTIFIED AC [200V/DIV]; TRACE 4 - LED CURRENT [1A/DIV]

WAVEFORM SHOWING DRAIN-SOURCE VOLTAGE

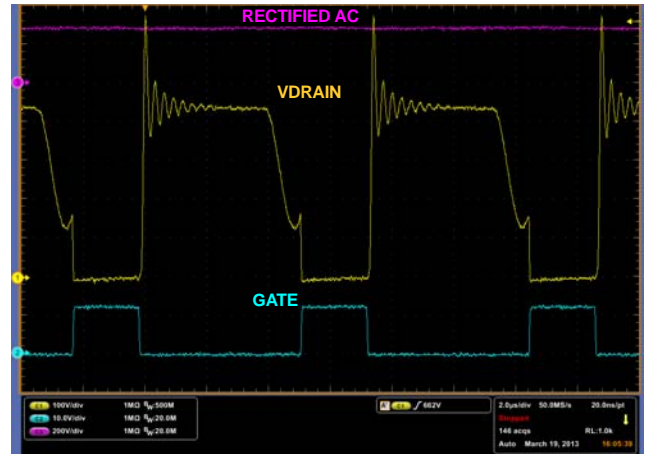

FIGURE 19. TRACE 1 - DRAIN VOLTAGE [100V/DIV]; TRACE 2 - GATE [10V/DIV]; SWITCHING WAVEFORMS

WAVEFORM SHOWING ZERO VOLTAGE SWITCHING BEHAVIOR

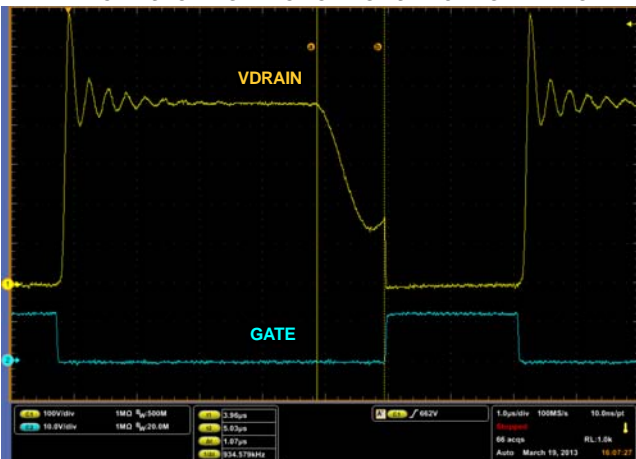

FIGURE 20. TRACE 1 - DRAIN VOLTAGE [100V/DIV]; TRACE 2 - GATE [10V/DIV]; TDELAY = 1.07µs; PARTIAL ZVS

WAVEFORM SHOWING OC (MOSFET CURRENT) WAVEFORM

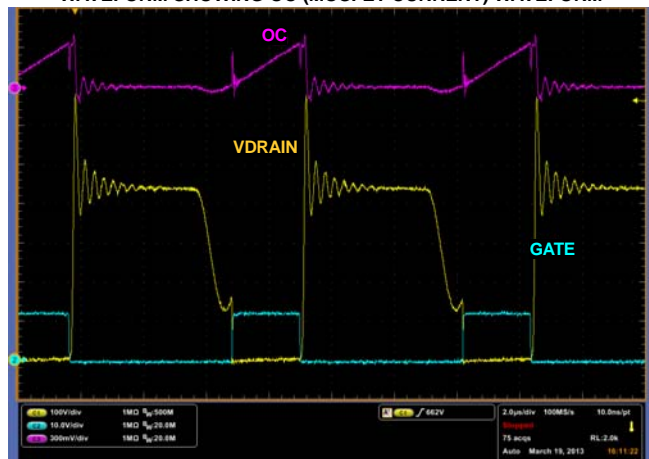

FIGURE 21. TRACE 1 - DRAIN VOLTAGE [100V/DIV]; TRACE 2 - GATE [10V/DIV]; TRACE 3 - DRAIN CURRENT OR OC [300mV/DIV]

Dimming Compatibility

The requirement to provide output dimming with low cost, TRIAC based, leading-edge phase dimmers introduced a number of trade-offs in the design.

Due to the much lower power consumed by LED based lighting, the current drawn by the lamp during dimming is below the holding current of the TRIAC within many dimmers. This causes undesirable behavior - limited dimming range and/or flickering when the TRIAC fires inconsistently. The relatively large impedance presented to the line by the LED driver allows significant ringing to occur due to the inrush current charging the input capacitance when the TRIAC turns on. This effect can cause similar undesirable behavior, as the ringing may cause the TRIAC current to fall to zero and turn off prematurely.

To overcome these issues, an active dimmer current holding circuit (DHC pin, R17), passive bleeder circuit (C14, R34) and an active damping circuit (Q3, D18, R44, C33 and R41) are incorporated into the design. These circuits result in increased power dissipation and hence reduce electrical efficiency and overall lamp efficacy. For non-dimming applications, these circuits can be omitted.

Dimming Curve

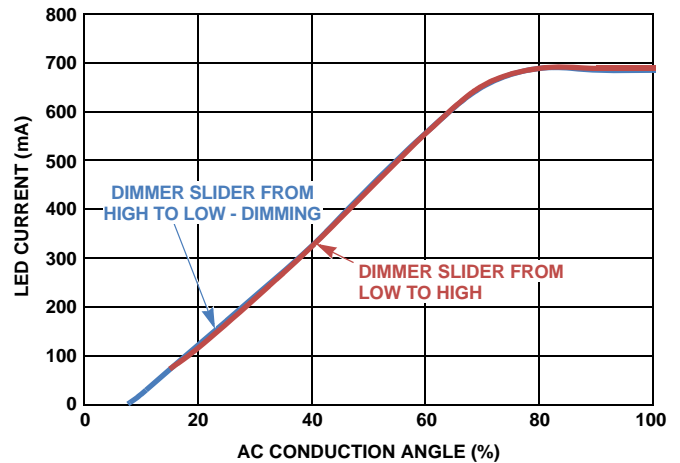

FIGURE 22. DIMMING CURVE - RAMPING DOWN AND RAMPING UP THE DIMMER; DIMMER USED: LEADING EDGE 600VA CHINESE DIMMER

TABLE 6. DIMMING DATA

CONDUCTION ANGLE (%)	LED CURRENT (mA)	% OF LED CURRENT MEASURED (%)	% OF LIGHT PERCEIVED BY HUMAN EYE
100	685	100	100
91	685	100	100
80	685	100	100
70	651	95.04	97.49
60	556	81.17	90.09
50	444	64.82	80.51
40	325	47.45	68.88
30	222	32.41	56.93
20	122	17.81	42.2
10	21	3.07	17.51
8	4	0.58	7.64

Dimming Waveforms

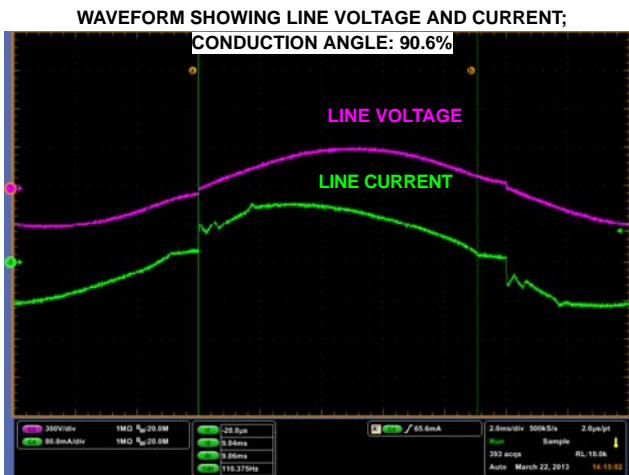

FIGURE 23. TRACE 3 - LINE VOLTAGE [300V/DIV]; TRACE 4 - LINE CURRENT [80mA/DIV]; 90.6% CONDUCTION ANGLE

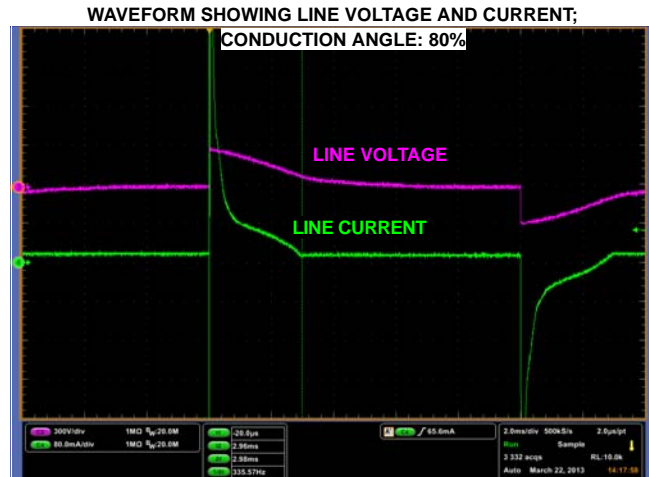

FIGURE 24. TRACE 3 - LINE VOLTAGE [300V/DIV]; TRACE 4 - LINE CURRENT [80mA/DIV]; 80% CONDUCTION ANGLE

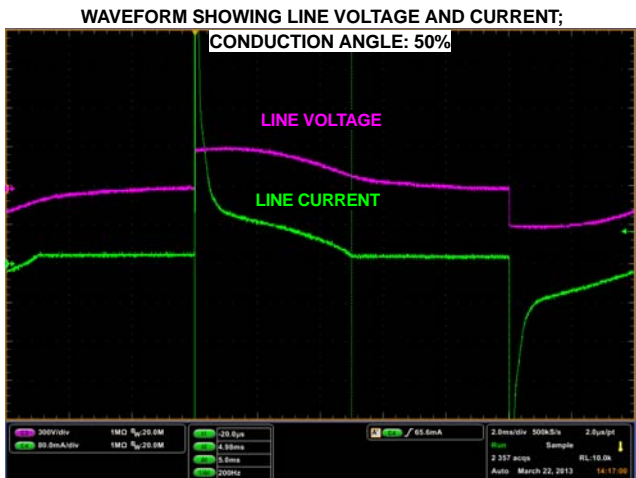

FIGURE 25. TRACE 3 - LINE VOLTAGE [300V/DIV]; TRACE 4 - LINE CURRENT [80mA/DIV]; 50% CONDUCTION ANGLE

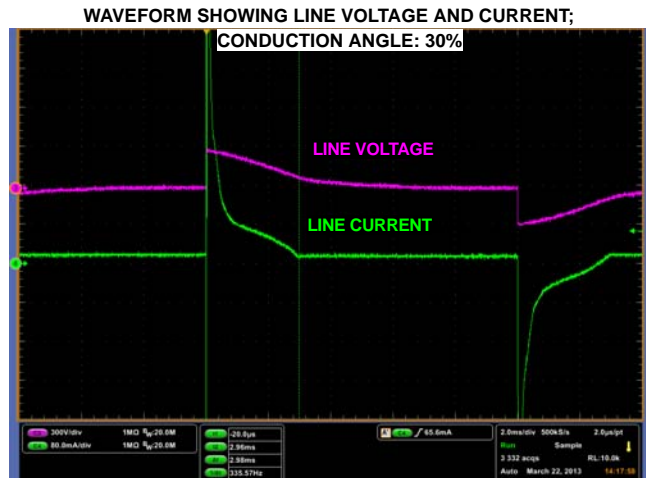

FIGURE 26. TRACE 3 - LINE VOLTAGE [300V/DIV]; TRACE 4 - LINE CURRENT [80mA/DIV]; 30% CONDUCTION ANGLE

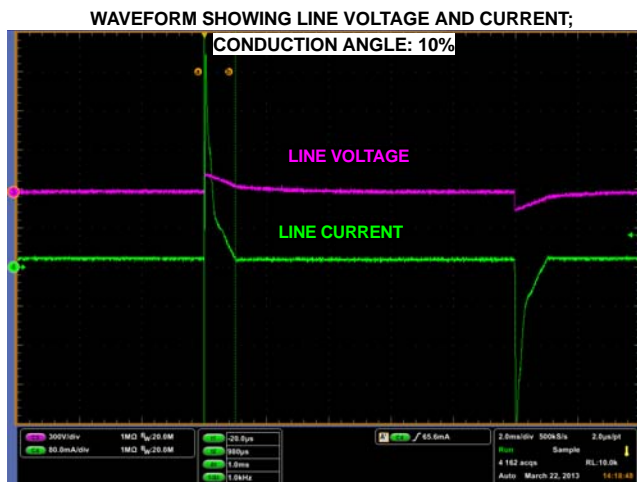

FIGURE 27. TRACE 3 - LINE VOLTAGE [300V/DIV]; TRACE 4 - LINE CURRENT [80mA/DIV]; 10% CONDUCTION ANGLE

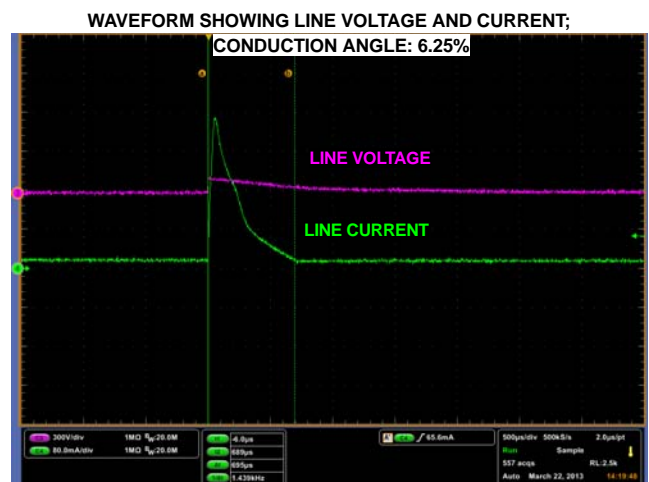

FIGURE 28. TRACE 3 - LINE VOLTAGE [300V/DIV]; TRACE 4 - LINE CURRENT [80mA/DIV]; 6.95% CONDUCTION ANGLE

Overvoltage Protection

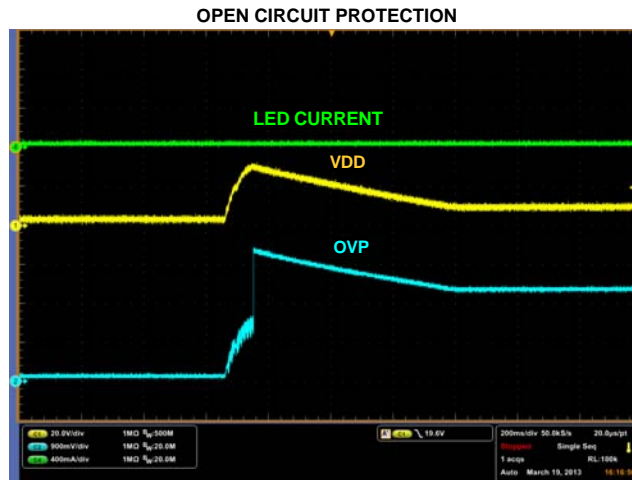

FIGURE 29. TRACE 1 - V_{DD} [20V/DIV]; TRACE 2- OVP [900mV/DIV]; TRACE 4 - LED CURRENT [400mA/DIV]

EMI Results - Cispr 22 Class B

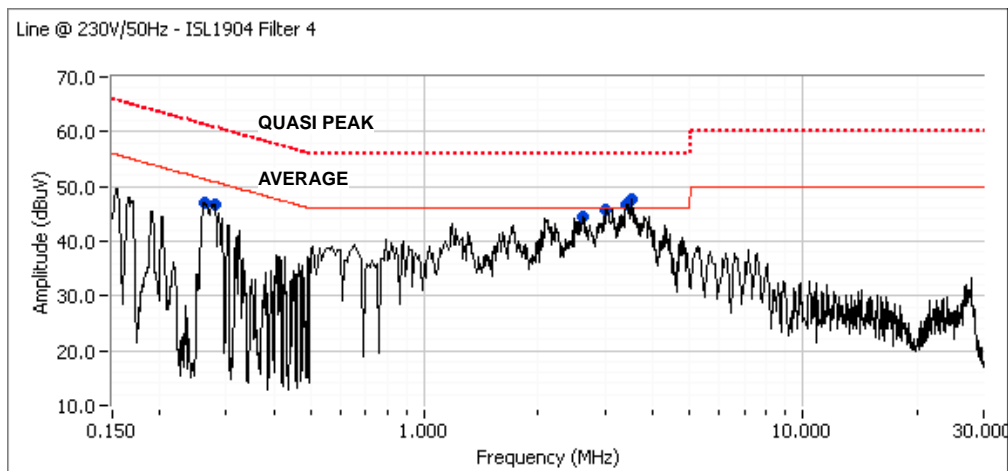

FIGURE 30. LINE AT 230V, 50Hz

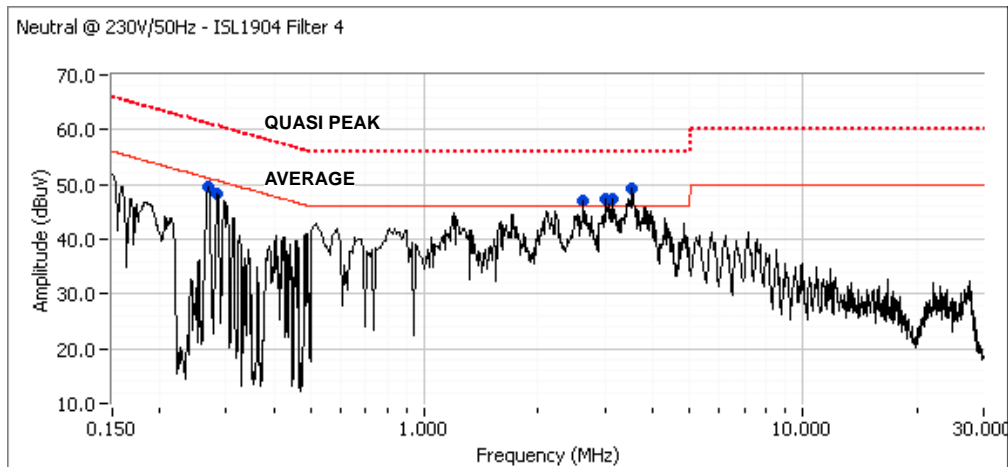

FIGURE 31. NEUTRAL AT 230V, 50Hz

Application Note 1845

TABLE 7. QUASI PEAK AND AVERAGE READINGS

FREQUENCY (MHz)	LEVEL (dB μ V)	AC LINE	CLASS B	
			LIMIT	MARGIN
3.513	45.5	Line 1	56	-10.5
0.268	49.3	Neutral	61.2	-11.9
2.61	44.1	Neutral	56	-11.9
3.009	43.6	Neutral	56	-12.4
3.535	43.6	Neutral	56	-12.4
3.134	43.5	Neutral	56	-12.5
0.284	47.9	Neutral	60.7	-12.8
3.41	43	Line 1	56	-13
3.008	42.2	Line 1	56	-13.8
2.612	41.2	Line 1	56	-14.8
0.262	46.3	Line 1	61.4	-15.1
3.513	30.8	Line 1	46	-15.2
3.535	30.7	Neutral	46	-15.3
0.28	44.5	Line 1	60.8	-16.3
3.41	29.4	Line 1	46	-16.6
3.134	29.4	Neutral	46	-16.6
3.009	29.2	Neutral	46	-16.8
2.61	28.2	Neutral	46	-17.8
3.008	27.7	Line 1	46	-18.3
0.268	32.9	Neutral	51.2	-18.3
2.612	25.9	Line 1	46	-20.1
0.262	30.6	Line 1	51.4	-20.8
0.284	27.8	Neutral	50.7	-22.9
0.28	25.6	Line 1	50.8	-25.2

Temperature Mapping

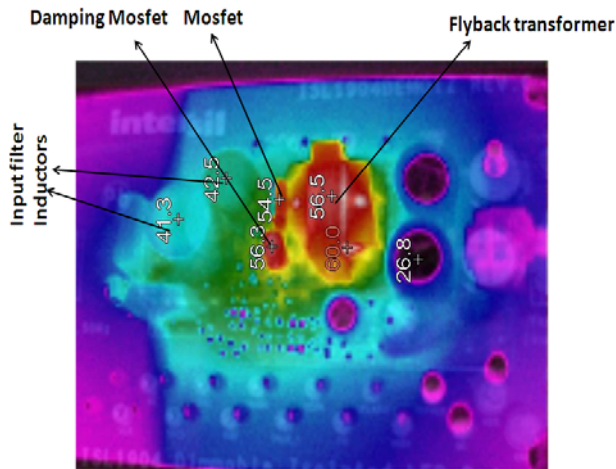

FIGURE 32. TOP SIDE TEMPERATURE SNAPSHOT DURING 100% CONDUCTION AND FULL LOADING

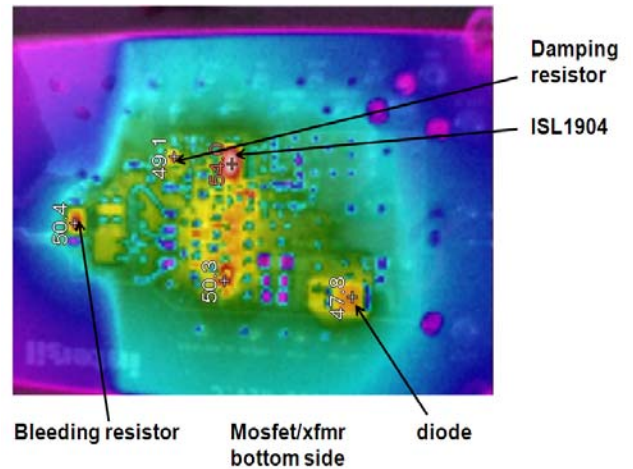

FIGURE 33. BOTTOM SIDE TEMPERATURE SNAPSHOT DURING 100% CONDUCTION AND FULL LOADING

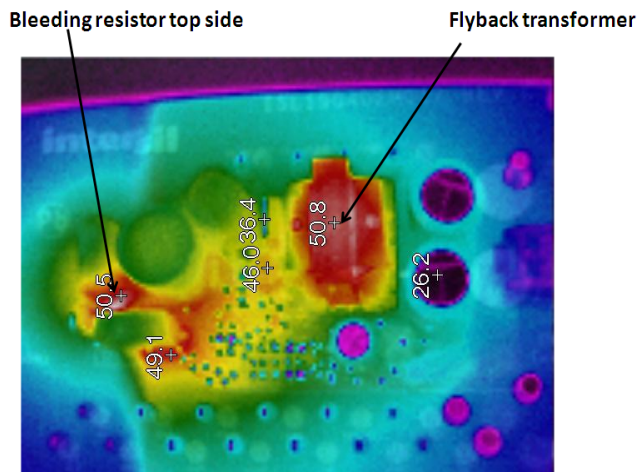

FIGURE 34. TOP SIDE TEMPERATURE SNAPSHOT DURING DEEP DIMMING

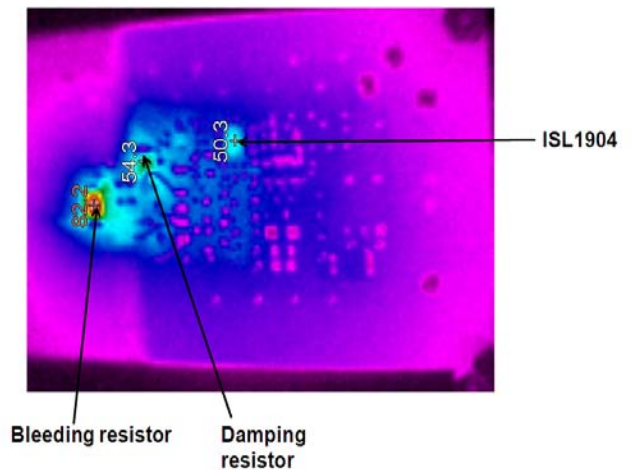
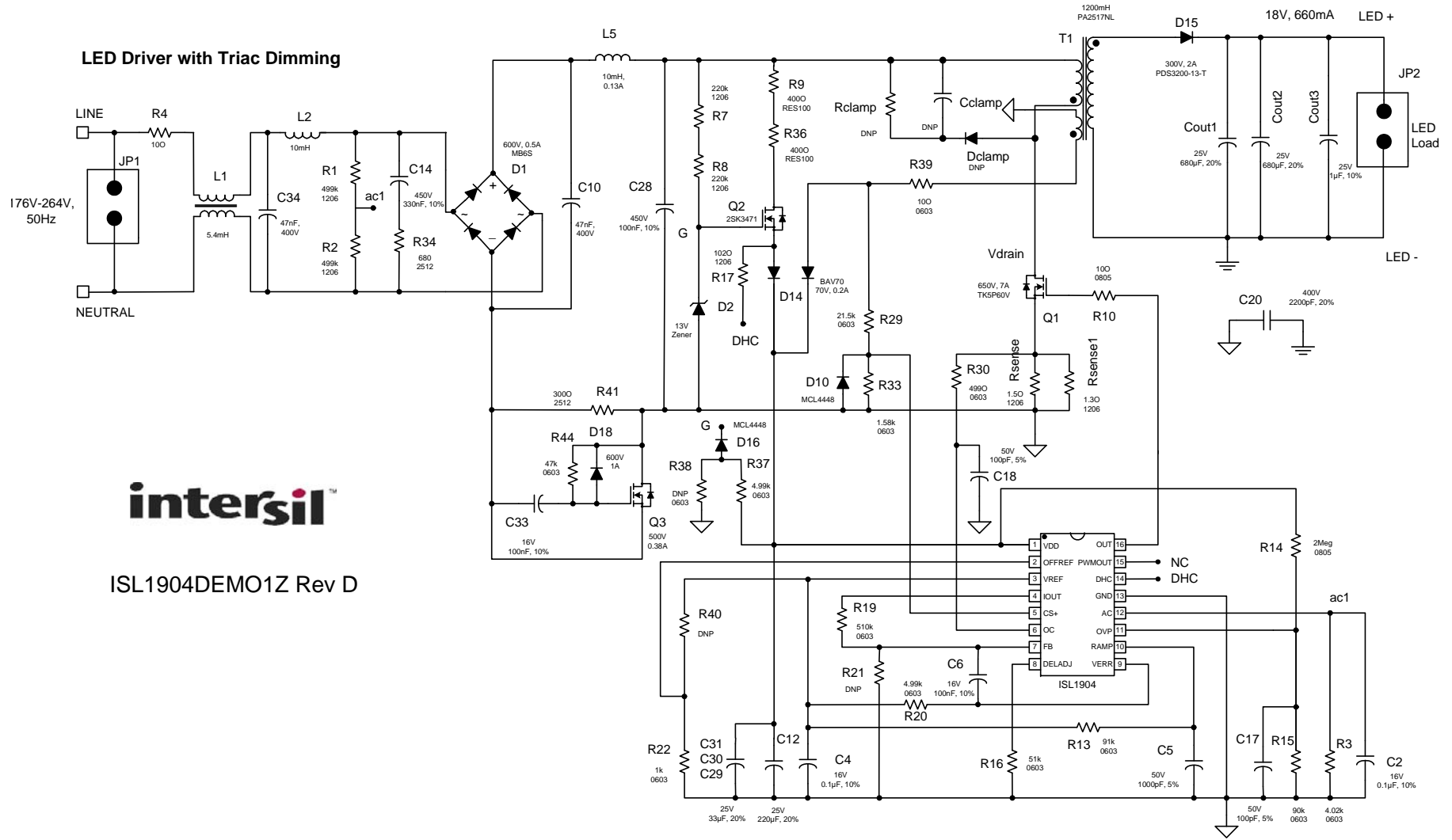

FIGURE 35. BOTTOM SIDE TEMPERATURE SNAPSHOT DURING DEEP DIMMING

Application Schematic

LED Driver with Triac Dimming



intersil

ISL1904DEMO1Z Rev D

Application Note 1845

Electrical Bill of Materials

TABLE 8. BOM FOR ISL1904DEMO1Z REV. D

QTY	REFERENCE DESIGNATOR	TYPE/MOUNT/PACKAGE/VOL/TOL/MAT	MANUFACTURER	MANUFACTURER PART #
2	C10, C34	Cap, TH, CAPR_190x90_200, 47n, 400V, 10%, X7R	PANASONIC	ECQ-E4473KF
3	C2, C4, C6	Cap, SM, 0603, 100n, 16V, 10%, MKT		H1045-00104-16V10
1	C5	Cap, SM, 1000p, 50V, 5%, MKT		H1045-00102-50V5
1	C12	Cap, TH, CAPR_248x354_100_P, 220 μ , 25V, 20%	RUBYCON	25PX220MEFC6.3X11
1	C14	Cap, TH, CAPR_472x248_400, 0.33 μ , 450V, 10%	PANASONIC	ECW-F2W334JAQ
1	C17	Cap, SM, 0603, 100p, 50V, 10%		H1045-00101-50V10
1	C18	Cap, SM, 0603, 10p, 50V, 5%, COG		
1	C20	Cap, TH, CAPR_394x500_160, 2200p, 400V	VISHAY	440LD22-R
1	C28	Cap, TH, CAPR_472x248_400, 0.1 μ , 400V, 10%	PANASONIC	ECQ-E4104KF
3	C29, C30, C31	Cap, SM, 1206, 33 μ , 25V, 20%		H1065-00336-25V20-T
1	C33	Cap, SM, 0805, 100n, 25V, 10%		
1	Cclamp	Cap, SM, 1206, DNP		
2	Cout1, Cout2	Cap, TH, CAPR_393x630_200_P, 680 μ , 25V, ALUM	PANASONIC	EEUFR1E681
1	Cout3	Cap, SM, 1206, 1 μ , 25V, 10%		
1	DB	Diode, SMD, DIO_MCC_MBS, 600V, 05A	MICRO COM	MB6D-TP-T
1	Dclamp	Diode, SMA, DNP		
1	D2	Diode, SM, SOD123FL, 13V, zener	MICRO COM	BZX84C20/MMSZ5243B-TP
2	D10, D16	Diode, SM, MCL4448, 75V, 200mA, general purpose	VISHAY	MCL4448
1	D14	Diode, SM, SOT23, 75V, 150mA, switching	NXP	BAV70-TP
1	D15	Diode, SM, SOD123FL, 600V, 1A, ultra fast	DIODES INC	PDS3200-13-T
1	D18	Diode, SM, DIO_POWERD1-5, 200V, 3A, ultra fast	MICRO COM	SM4005PL-TP
1	F1	RES, TH, RES100, 10 Ohms, fusible	YAGEO	FKN1WSJR-52-10R
1	L1	IND, TH, 11x17x17mm, 5.4mH, common mode	WURTH	744862056
2	L2, L5a	IND, TH, 10mH, Radial	RENCO	
1	Q1	MOSFET, TH, TO251, 600V, 7.5A	TOSHIBA	TK5Q60V
1	Q2	MOSFET, SMD, SOT89, 500V, 0.5A	TOSHIBA	2SK3471
1	Q3	MOSFET, TH, TO92, 500V, 0.38A	FAIRCHILD	FQN1N50CTA
1	Rclamp	Res, SM, 1206, DNP		
1	Rsense	Res, SM, 1206, 1.5, 1%, Thick Film		
1	Rsense1	Res, SM, 1206, 1.2, 1%, Thick Film		-
2	R1, R2	Res, SM, 1206, 499k, 1%, Thick Film		H2511-04993-1/8W1
1	R3	Res, SM, 0603, 4.02k, 1%, Thick Film		H2511-04021-1/16W1
2	R7, R8	Res, SM, 1206, 220k, 1%, Thick Film		H2513-02203-1/8W5
2	R9, R36	Res, SM, 1210, 499, 1%, Thick Film		
2	R10, R39	Res, SM, 0805, 10, 1%, Thick Film		H2512-00100-1/10W1
1	R13	Res, SM, 0603, 43k, 1%, Thick Film		H2511-04302-1/16W5
1	R14	Res, SM, 0805, 2Meg, 1%, Thick Film		
2	R15, R16	Res, SM, 0603, 91k, 1%, Thick Film		H2511-09112-1/16W1

Application Note 1845

TABLE 8. BOM FOR ISL1904DEMO1Z REV. D (Continued)

QTY	REFERENCE DESIGNATOR	TYPE/MOUNT/PACKAGE/VOL/TOL/MAT	MANUFACTURER	MANUFACTURER PART #
1	R17	Res, SM, 1206, 102, 1%, Thick Film		H2513-01020-1/8W1
1	R19	Res, SM, 0603, 510k, 1%, Thick Film		H2511-05103-1/16W5
2	R20, R37	Res, SM, 0603, 4.99k, 1%, Thick Film		H2511-04991-1/16W1
2	R21, R40	Res, SM, 0603, DNP		
1	R22	Res, SM, 0603, 1k, 1%, Thick Film		
1	R29	Res, SM, 0603, 21.5k, 1%, Thick Film		H2511-02152-1/16W1
1	R30	Res, SM, 0603, 499, 1%, Thick Film		H2511-04990-1/16W1
1	R33	Res, SM, 0603, 1.58k, 1%, Thick Film		
1	R34	Res, SM, 2512, 680, 1%, Thick Film		
1	R38	Res, SM, 0603, DNP		
1	R41	Res, SM, 2512, 300, 1%, Thick Film		
1	R44	Res, SM, 1206, 47k, 1%, Thick Film		
1	T1	xfmr, TH, 1.2mH, 8:1 turns ratio	PULSE	PA2517NL
1	U1	IC, SM, QSSOP, ISL1904FAZ	INTERSIL	ISL1904FAZ

Assembly Drawing

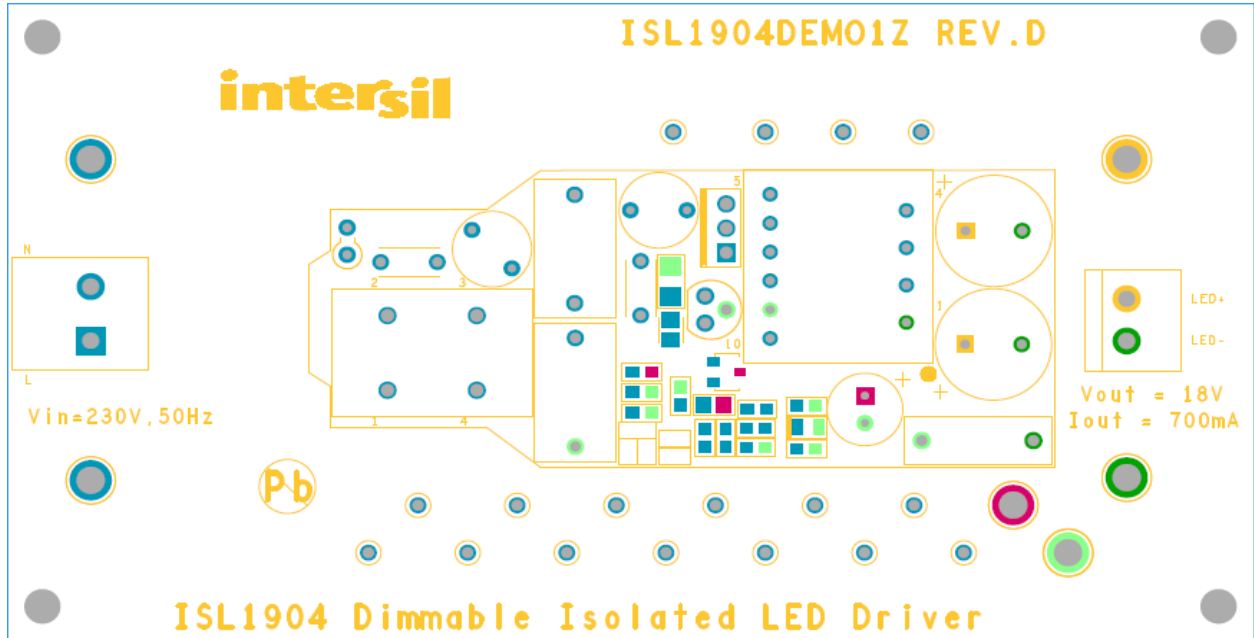

FIGURE 36. SILKSCREEN TOP

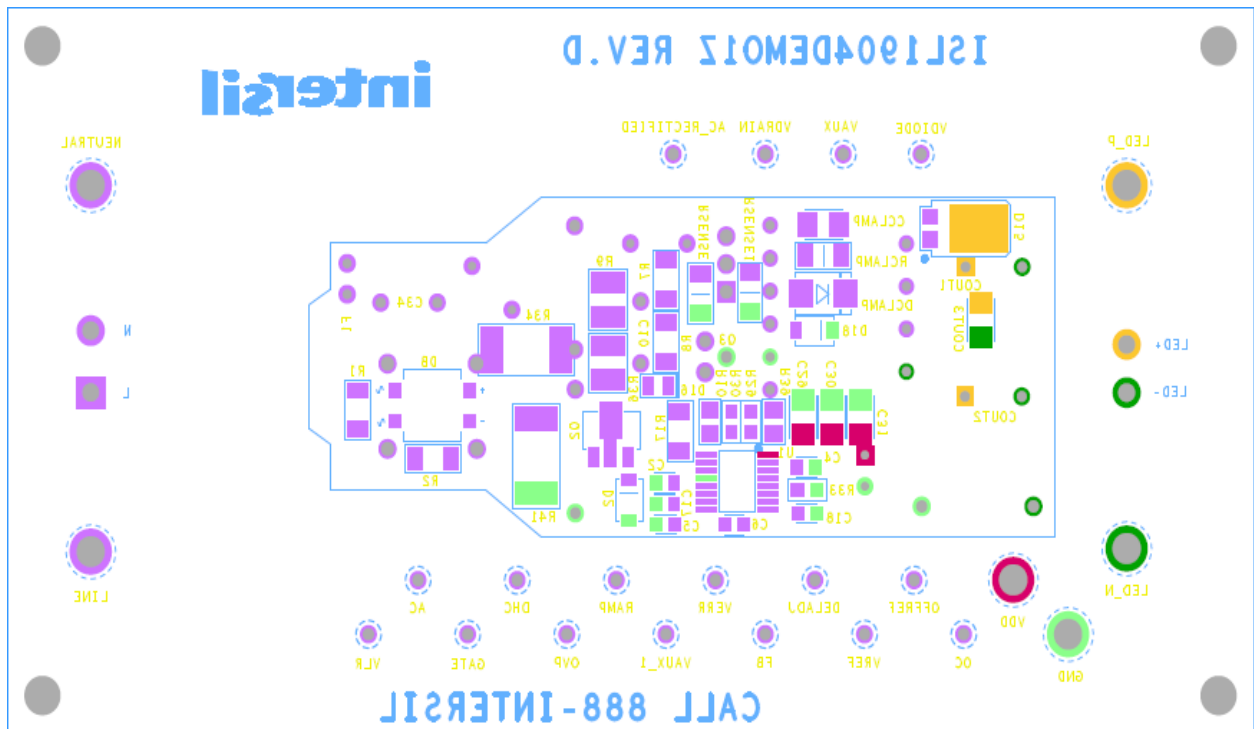

FIGURE 37. SILKSCREEN BOTTOM

PCB Layout

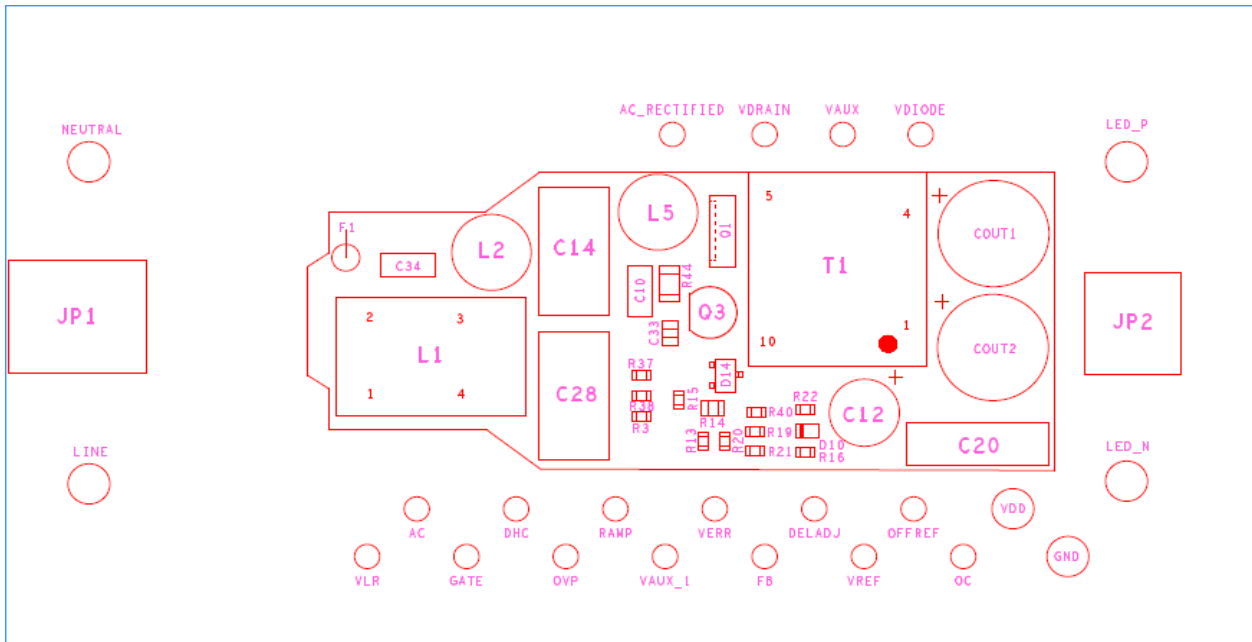

FIGURE 38. ASSEMBLY TOP

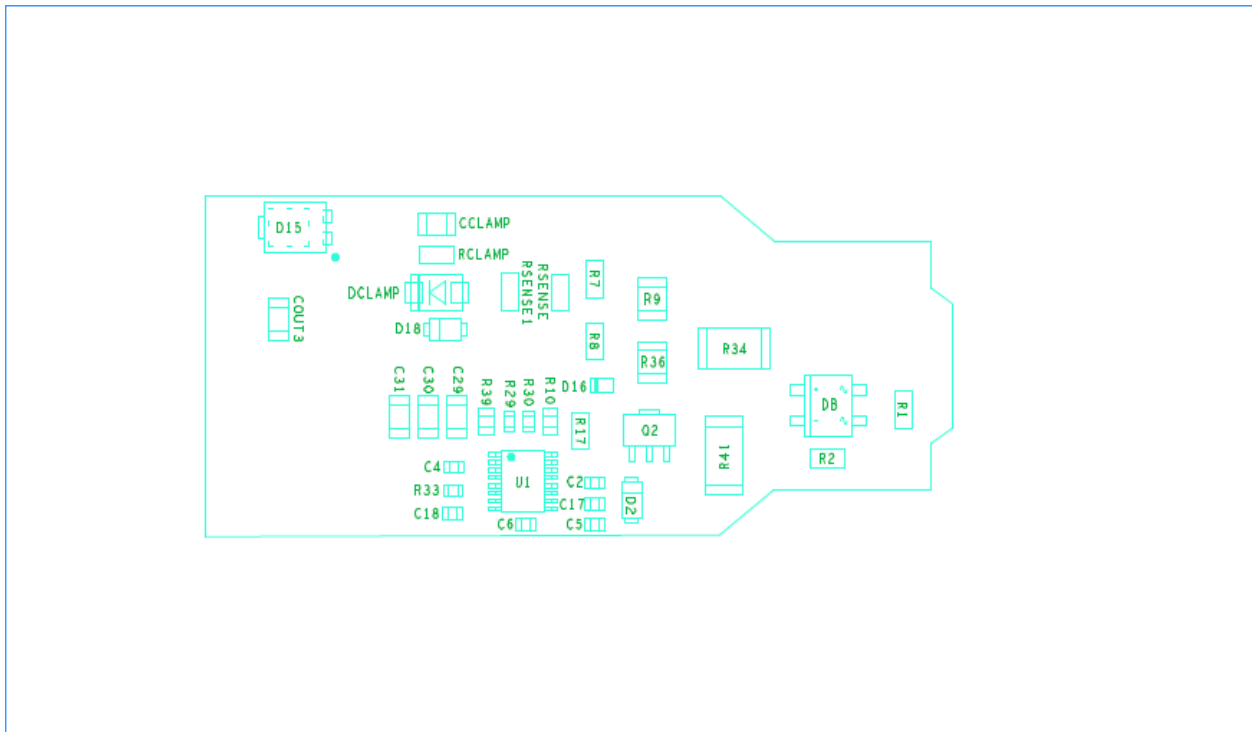

FIGURE 39. ASSEMBLY BOTTOM

Intersil Corporation reserves the right to make changes in circuit design, software and/or specifications at any time without notice. Accordingly, the reader is cautioned to verify that the Application Note or Technical Brief is current before proceeding.

For information regarding Intersil Corporation and its products, see www.intersil.com